

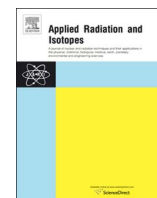

Contents lists available at ScienceDirect

Applied Radiation and Isotopes

journal homepage: www.elsevier.com/locate/apradiso

Optically stimulated luminescence of natural NaCl mineral from Dead Sea exposed to gamma radiation

J. Roman-Lopez^{a,*}, Y.I. Piña López^b, E. Cruz-Zaragoza^c, J. Marcazzó^d

^a CONACYT-Instituto de Ciencias Nucleares, Universidad Nacional Autónoma de México, A.P.70-543, 04510 Ciudad de México, México

^b Facultad de Ciencias, Universidad Nacional Autónoma de México, 04510 Ciudad de México, México

^c Instituto de Ciencias Nucleares, Universidad Nacional Autónoma de México, A.P.70-543, 04510 Ciudad de México, México

^d Instituto de Física Arroyo Seco (UNCPBA) and CIFICEN (UNCPBA-CICPBA-CONICET), Pinto 399, 7000 Tandil, Argentina

ARTICLE INFO

Keywords:

Dead Sea NaCl
CW-OSL response
⁶⁰Co-gamma rays

ABSTRACT

In this work, the continuous wave - optically stimulated luminescence (CW-OSL) emissions of natural salt minerals, collected from Dead Sea in summer of 2015, were studied. The CW-OSL dose response of natural salt showed a linear range between 0.5 Gy and 10 Gy of gamma radiation of ⁶⁰Co. Samples exposed at 3 Gy exhibited good repeatability with a variation coefficient of 4.6%. The CW-OSL response as function of the preheating temperature (50–250 °C) was analyzed. An increase of 15% of the CW-OSL response was observed in NaCl samples during storage period of 336 h. The results showed that the natural Dead Sea salt minerals could be applied as natural dosimeter of gamma radiation.

1. Introduction

The luminescence of natural (halite) and synthetic NaCl (pure and doped) minerals have been extensively studied due to both their radiation sensitivity and TL and OSL properties for applications in retrospective dosimetry, geological dating and identification of irradiated food (Timar-Gabor and Trandafir, 2013; Spooner et al., 2012; Bailey et al., 2000; Zhang et al., 2005; Cruz-Zaragoza et al., 2006; Fuochi et al., 2008). In this sense, Hunter et al. (2012) investigated the emission spectra, using thermoluminescence (TL) of commercial salts from Australia, Europe, Asia and America. They found that the most samples presented strong TL emissions at 590 nm and proposed the NaCl as an adaptable retrospective dosimeter with the restriction of use samples without exposure to daylight, due to that approximately 90% of the peak at 260 °C was bleached after 10 min of exposure to light. However, Druzhyňa et al. (2016) observed in Israeli NaCl samples an optical bleaching of the TL intensity of around 30% for one day of exposure. On the other hand, the optically stimulated luminescence (OSL) response of natural halite presented several effects which must be considered for the use of these minerals as retrospective and accident dosimeter in radiological events. Such effects are: the appearing of anomalous fading, sensitivity changes caused by thermal and optical influence, regeneration of the OSL intensity effect, caused for subsequent OSL readouts after a delay time, and strong optical bleaching conditioned the application of sealed samples. The optical sensitization

of the CW-OSL response in halite samples was studied by Biernacka et al. (2016) using blue and green light for bleaching of samples after readout. When the samples were bleaching with blue light the sensitization of the OSL response was higher than observed using green light bleaching. A regeneration effect for both types of bleaching light was also observed with maxima of OSL intensity at delay time of 10⁴ s. In this sense, Christiansson et al. (2014) investigated the CW-OSL response of four distinct brands of salt under laboratory and field conditions (light, temperature and type of container). It was found a variance in measurements of absorbed dose of ± 7% between the four brands and a difference of ± 15% in samples mixed in the container compared to samples located at the center of the container, and an inverse fading of 17–31% after 142 days of storage. This work is focusing in determine the CW-OSL dosimetric properties of natural NaCl samples, collected in the Dead Sea, and exposed to ⁶⁰Co gamma rays for its application as natural dosimeter. The dosimetric properties studied were dose-response in the range 0.2–20 Gy, repeatability of the OSL signal after ten cycles of irradiation-readout and preheating stability from 50 °C up to 230 °C. In addition, structural and chemical characterization was performed by X-Ray Diffraction (XRD) and Energy Dispersive Spectroscopy (EDS).

2. Materials and methods

Natural NaCl minerals were collected, at a depth of approximately

* Corresponding author.

E-mail address: jesus.roman@nucleares.unam.mx (J. Roman-Lopez).

<http://dx.doi.org/10.1016/j.apradiso.2017.05.001>

Received 7 December 2016; Received in revised form 29 April 2017; Accepted 2 May 2017
0969-8043/ © 2017 Elsevier Ltd. All rights reserved.

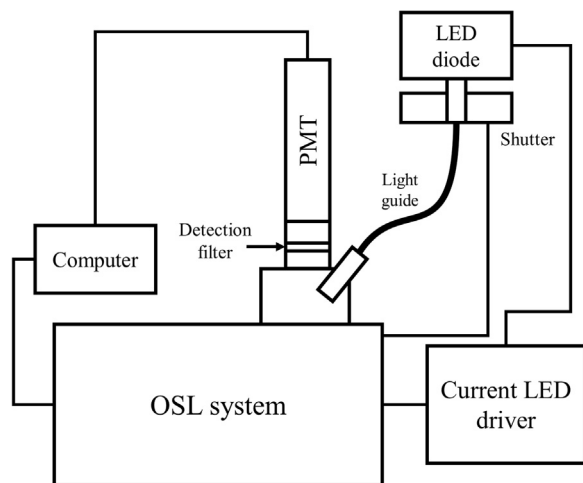

Fig. 1. Custom-made OSL schematic diagram. The light stimulation is centered on the samples using a light guide (Marcuzzó et al., 2011).

1 m, in the Dead Sea lake. Previously to irradiation and CW-OSL analysis the NaCl minerals were kept into a beaker at room temperature (20–25 °C) for 1 week and then they were grinding to fine powder carefully to avoid a spurious luminescence response. The NaCl minerals were chemically characterized by Energy Dispersive Spectroscopy (EDS) using a JEOL JSM-5900 with oxford INCA 200 detector. X-ray Diffraction (XRD) was carry out by D8-advance Bruker diffractometer with Cu-K α radiation ($\lambda = 1.5406 \text{ \AA}$) for study the structural characteristics of the natural NaCl. The XRD measurements were taken from 10° up to 100° (2 θ) with steps of 0.0197°. Samples of approximately 10 mg of natural NaCl were weighed and mounted on aluminum discs for ^{60}Co gamma irradiation and CW-OSL luminescence study. The aliquots were exposed to ^{60}Co gamma rays using a Gammacell-200 irradiator with a dose rate of 0.1426 Gy/min at sample position. A custom-made OSL equipment was used to perform the CW-OSL decay measurements. Fig. 1 shows a schematic diagram of custom-made OSL equipment which is composed by a OSL system, current LED driver, LED diode, computer and a detection unit (PMT). The details of the parts were reported in Marcuzzó et al. (2011). The optical stimulation of the NaCl minerals was made using a Luxeon V Star blue Lambertian light emitting diode (LED) with maximum emission at $455 \pm 25 \text{ nm}$ and provide a luminous flux of 700 mW. The current of the LED, during the sample stimulation was controlled with a Newport laser diode driver model 525B. Between the stimulation light and the sample two long-pass Schott GG-420 filters, with maximum transmission of 0.91 for wavelengths higher than 420 nm and a transmission less than 10^{-6} at shorter wavelengths, were placed. The luminescence of the stimulated sample was observed trough two optical bandpass filters Hoya U-340 and detected by a photon counting Hamamatsu H9319-02 photomultiplier tube (PMT) that cover a spectral range of 300–850 nm.

3. Results

3.1. Sample characterization

The structure and chemical composition of natural NaCl minerals were analyzed by XRD and EDS. In Fig. 2 is shown the diffraction pattern and reflection planes associated to NaCl structure. The NaCl minerals presented a cubic system with a space group $Fm\bar{3}m$ and cell parameters of $a=b=c=5.6 \text{ \AA}$. These values were compared with diffraction patterns, R070292 and R070534, of natural NaCl minerals obtained from RRUFF data base.

Fig. 3 shows the EDS analysis of NaCl minerals composed by Sodium (Na), Chloride (Cl) and Oxygen (O) elements with atomic percentage (average of 15 measurements) of 37.88%, 46.29% and 15.82%,

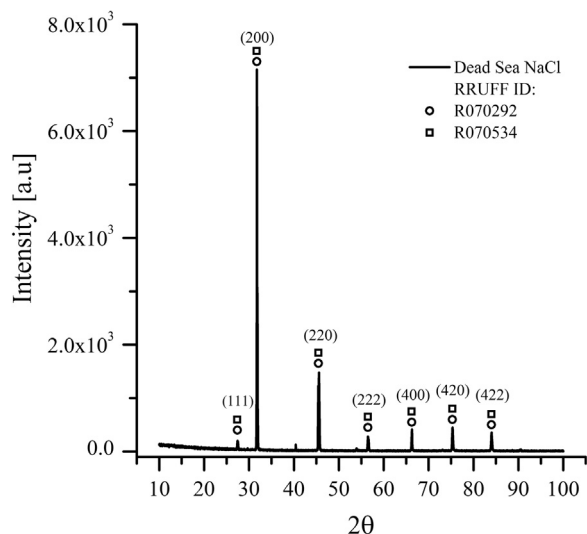

Fig. 2. X-ray diffraction pattern of Dead Sea Salt minerals. The symbols represent the NaCl reflections corresponding to diffraction card R070292 and R070534 of the RRUFF database.

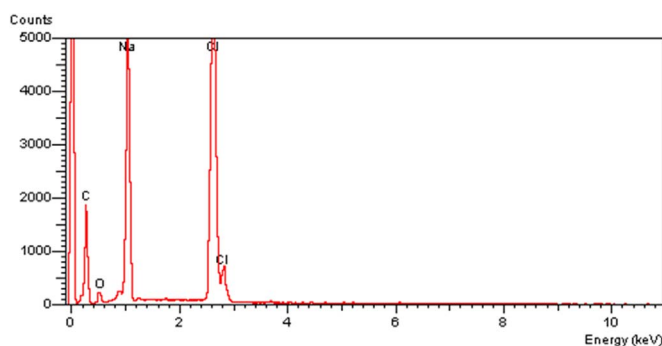

Fig. 3. EDS spectra with the chemical composition of Dead Sea NaCl minerals.

respectively. The incorporation of O ions could be related with the adding of water in the sample due to humidity environment of the sea.

3.2. CW-OSL response

Continuous CW-OSL response of natural NaCl minerals was measured using the followed conditions: blue light at 455 nm with 497 mA of current intensity and a stimulation time of 120 s. In Fig. 4 is shown the as-obtained (natural response) and irradiated (0.2 Gy of ^{60}Co) CW-OSL response of Dead Sea minerals. At two seconds of light stimulation the CW-OSL intensity decayed 58% and for 20 s the intensity decreased 70.3%. After that, the CW-OSL intensity exhibited a slow decay up to a time of 120 s. These behaviors can be related with three different decay components.

In this sense, the CW-OSL decay curve was fitted applying the Eq. (1) that describe the summation of three decay exponentials due to the stimulated light release electrons from more than one trap. Therefore, the OSL response of each exponential decay can be produced by one electron and hole trap via conduction band transport, the recombination of electrons at hole traps (concentration m) is carry out without re-trapping and assuming a quasi-stationary free electron density (quasi equilibrium approximation) (McKeever et al., 1997; Bøtter-Jensen et al., 2003; Yuhikahara and McKeever, 2011):

$$I_{OSL} = -\frac{dm}{dt} = \frac{dn_1}{dt} + \frac{dn_2}{dt} + \frac{dn_3}{dt} = I_{10} \exp\left(-\frac{t}{\tau_1}\right) + I_{20} \exp\left(-\frac{t}{\tau_2}\right) + I_{30} \exp\left(-\frac{t}{\tau_3}\right) \quad (1)$$

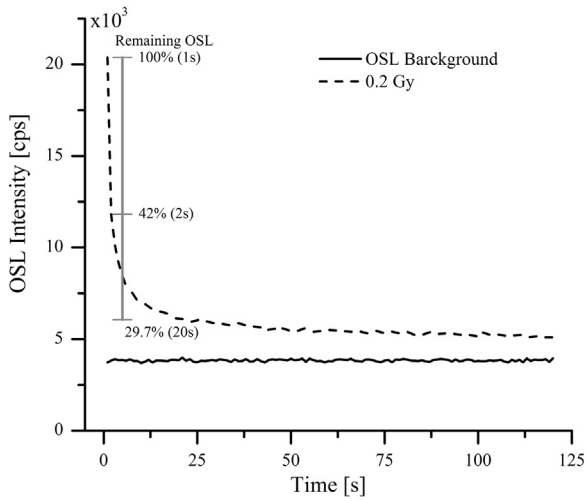

Fig. 4. CW-OSL curve decay of Dead Sea NaCl minerals as-obtained and exposed at 0.2 Gy with ^{60}Co gamma rays.

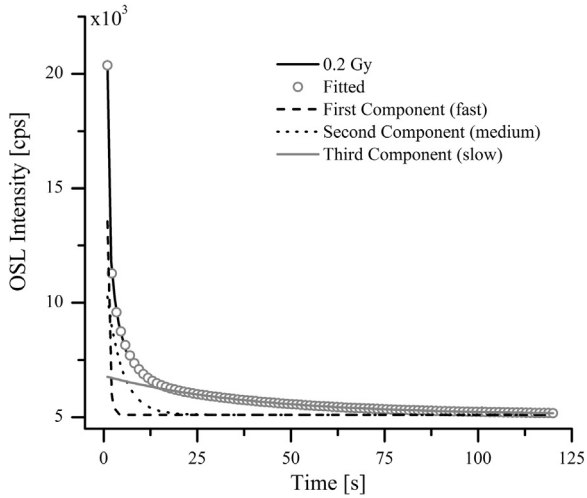

Fig. 5. Fitting curves of the CW-OSL response of NaCl minerals exposed at 0.2 Gy. The CW-OSL curve was fitted using three exponential components.

where n_i and I_{i0} ($i=1, 2$ and 3) are the initial trapped electron concentration and OSL intensity at $t=0$, and τ_i ($i=1, 2$ and 3) is the CW-OSL decay constant (free electron recombination lifetime) for each trap level. As is shown in Fig. 5, the fitted exponential components decayed with a lifetime of 0.49 s (fast), 4.06 s (medium) and 38.57 s (slow). Also, they presented initial intensities of 64709.82, 6593.97 and 1706.04, respectively.

On the other hand, the CW-OSL dose response was analyzed from 0.2 up to 20 Gy of ^{60}Co gamma radiation. The OSL response of each reading was estimated using the first 20 s of the decay curve. Therefore, the NaCl minerals showed a linear CW-OSL dose response range between 0.5 and 10 Gy (Fig. 6 upper). For adsorbed doses of 16 and 20 Gy the response of the minerals is higher than the expected intensity described by the linear fit. This increase of the CW-OSL response could be associated with the sensitization of the samples at high doses of ^{60}Co radiation. For study the repeatability of the CW-OSL response the NaCl minerals were irradiated (3 Gy) and read ten times under the same condition. The NaCl minerals presented a good repeatability with variation coefficient of 4.6% (Fig. 6 lower).

The preheated temperature (10 s) on the CW-OSL response was analyzed in NaCl minerals from 50 °C up to 250 °C. The irradiated samples were heated with a rate of 5 °C/s and optically stimulated at room temperature. The CW-OSL intensity was obtained using the value of first second of light stimulation less the value of last second of

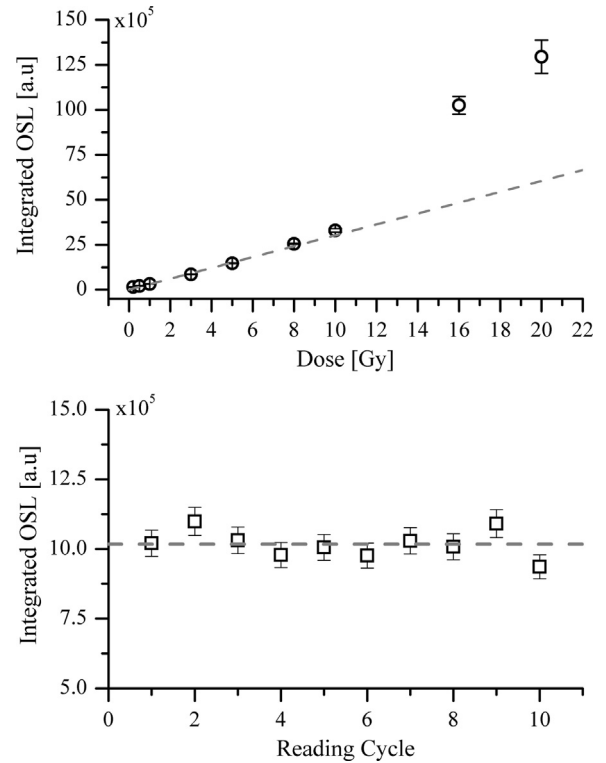

Fig. 6. Dose-response CW-OSL, from 0.2 up to 20 Gy (upper), and repeatability (3 Gy), after ten cycles of irradiation-reading (lower), of the NaCl minerals. Each point represents the integral of the first 20 s of the CW-OSL response.

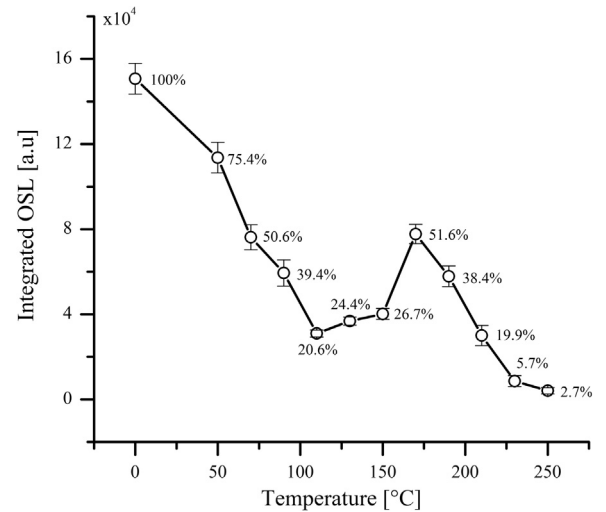

Fig. 7. Integrated CW-OSL response of preheated NaCl minerals. The error bars represent the deviation standard of the CW-OSL response of three aliquots.

illumination. The CW-OSL intensity of each temperature represents the average of three aliquots. As is shown in Fig. 7, the CW-OSL intensity of the NaCl samples annealed from 50 °C up to 110 °C decreased for each temperature approximately 24.6%, 49.4%, 60.6% and 79.4%. For a temperature range from 130 °C up to 190 °C, the samples exhibited a sensitivity change which could be related to the activation of optical inactive traps that increased the CW-OSL intensity. After that, the OSL intensity decayed 97.3% for a preheated temperature of 250 °C.

The fading of the CW-OSL response was carry out on irradiated (3 Gy) NaCl samples stored from 1 h up to 336 h at room temperature and darkness (Fig. 8). The CW-OSL response of samples decreased 40% at 3 h. After this time, the CW-OSL response decreased 24%, 26%, 9% and 12% for lengths of time of 6, 24, 72 and 144 h, respectively. At the

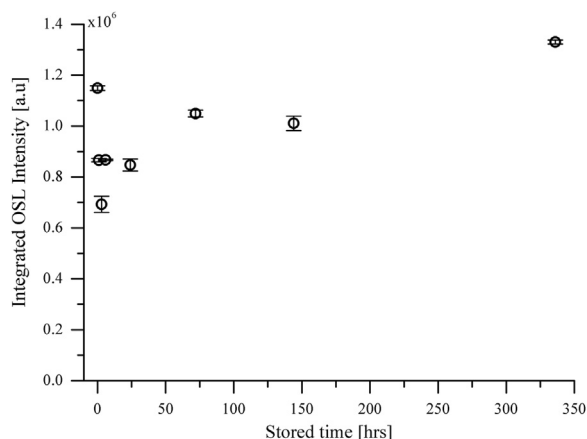

Fig. 8. Fading of the integrated (first 20 s) CW-OSL response of NaCl minerals. The error bars represent the deviation standard of two samples.

end of 336 h of stored, the samples presented a CW-OSL response 15% more high than the samples immediately analyzed.

4. Discussion

Dead sea halite (NaCl) minerals crystallized with oxygen saturated conditions showed the presence of minor traces of elements such as Ca, Mg, K, Mn and Br. Herut et al. (1998) reported the chemical composition of Dead Sea minerals recollected from a depth of 40 m, 120 m and 250 m. It was found that the minerals are composed by traces of Ca, Mg, K, Mn, Br, Cd, Pb, Zn and Ni elements with different concentration depending on the collected place. In this study, the halite minerals were sampled near to surface of the Dead Sea Lake at a depth of approximately 1 m (summer of 2015) and characterized by a EDS detector with about 1000 ppm as detection limit. The EDS shows the following composition of the sample: Na, Cl and O elements in atomic percent of 37.88%, 46.29% and 15.82%, respectively. Thus, the studied NaCl minerals could be contaminated with traces of other elements that were not identified in our EDS detector. The CW-OSL response of different NaCl minerals, mainly household salts, have been studied and reported for several authors. Similar CW-OSL curve decay was observed by Thomsen et al. (2002) and Bernhardsson et al. (2009) in common salt stimulated using blue light LEDs at 470 nm, before OSL readout the samples were preheated at 150 °C and 220 °C for 10 s, respectively. In our case, the CW-OSL response was obtained at room temperature (~25 °C) to study the optical behavior of electrons trapped in shallow and deep traps. Therefore, the CW-OSL response was fitted using the summation of three exponential decay components (fast, medium and slow), where the OSL decay constant is related with the photoionization cross section of the traps and the stimulation photon flux (Bøtter-Jensen et al., 2003). NaCl minerals exposed to ⁶⁰Co gamma radiation presented a wide linear response in the range from 0.5 up to 10 Gy. Nevertheless, a low dose response study from 1 mGy up to 500 mGy could be performed for extent the linear response of the NaCl minerals. Bernhardsson et al. (2009) analyzed the dose response of commercial NaCl samples (irradiated with ⁶⁰Co gamma rays) between 1 mGy and 10 Gy and found a linear relationship from 1 mGy up to 0.1 Gy.

On the other hand, diverse CW-OSL investigations reported a sensitivity change in the OSL response of NaCl samples when they were irradiated and readout for repeated times (Ekendahl and Judas, 2011; Biernacka et al., 2016). For avoid some change in the OSL sensitivity during the repeatability procedure, the NaCl samples were exposed to blue light for 10 min after readout and before irradiation, *i.e.* release the remained electron trapped in deep traps that could increase the sensitivity of the response. After ten cycles of irradiation and readout a good repeatability (4.6%) was observed in the CW-OSL response without evidence of drastic change in the OSL sensitivity.

Other important factor that affect the CW-OSL sensitivity is the temperature, the NaCl minerals also present a thermoluminescence response related with the same traps responsible for the OSL emissions. In this sense, the CW-OSL response of the NaCl samples was measured after a heated to different temperatures from 50 °C to 250 °C with a heating rate of 5 °C/s (Fig. 7). The results showed that the CW-OSL intensity presented a sensitivity change between 130 °C and 190 °C temperature. A similar behavior in the range of 120–220 °C was observed by Zhang et al. (2005) in analytical NaCl synthetic samples. They suggested that the increase of the OSL intensity is related with the transfer of electrons from non-light sensitive to light sensitive traps.

Fading study (Fig. 8) in the NaCl samples presented a less decreased (12%) of the CW-OSL response at 144 h than that (40%) at 3 h. This behavior of the CW-OSL response could be associated with the transference of charge between thermal unstable shallow traps and stable deep traps. Also, an increase about of 15% of the CW-OSL response was observed in samples stored by 336 h. Further investigations are necessary to improve the fading response in the NaCl samples. In this sense, Christiansson et al. (2014) studied fading under light-sealed conditions and observed a signal increases (inverse fading) during 142 day storage period in household NaCl samples. On the contrary, a rapid fading (35% after 7 days) of the CW-OSL response was obtained in household salt by Timar-Gabor and Trandafir (2013).

5. Conclusions

The CW-OSL properties of repeatability, dose response, preheating stability and fading in Dead Sea NaCl samples using ⁶⁰Co gamma radiation were analyzed. NaCl minerals showed an intense CW-OSL decay curve composed by three exponential decay components. The samples presented a wide linear range of dose response (0.5 up to 10 Gy) and good repeatability of 4.6% after ten cycles of irradiation and readout. The samples exhibited an enhancement of sensitivity when they were preheated between 130 °C and 190 °C. At 336 h of stored the samples showed an increase of 15% of the CW-OSL. Based on these results the NaCl minerals could be used as natural dosimeter of ⁶⁰Co gamma radiation.

Acknowledgments

The second author (Y.I. Piña López) acknowledges the financial support from Science Faculty-UNAM and ICN-UNAM for the crystals sampling. The authors are grateful to Francisco García Flores and Benjamin Leal Acevedo (ICN-UNAM) for their assistance in the irradiation of samples. Also, thank José Rangel Gutiérrez for fabrication of the special pieces for custom-made OSL equipment and Rafael Ivan Puente Lee (USAI of Chemistry Faculty-UNAM) for the SEM-EDS analyses of the samples. This work was partially supported by PAPIIT-DGAPA UNAM under projects number IN115814 and IN112617.

References

- Bailey, R.M., Adamiec, G., Rhodes, E.J., 2000. OSL properties of NaCl relative to dating and dosimetry. *Radiat. Meas.* 32, 717–723.
- Bernhardsson, C., Christiansson, M., Mattsson, S., Rääf, C.L., 2009. Household salt as a retrospective dosimeter using optically stimulated luminescence. *Radiat. Environ. Biophys.* 48, 21–28.
- Biernacka, M., Majgier, R., Maternicki, K., Liang, M., Mandowski, A., 2016. Peculiarities of optically stimulated luminescence in halite. *Radiat. Meas.* 90, 247–251.
- Bøtter-Jensen, L., McKeever, S.W.S., Wintle, A.G., 2003. *Optically Stimulated Luminescence Dosimetry*, first ed. Elsevier, Amsterdam.
- Christiansson, M., Bernhardsson, C., Geber-Bergstrand, T., Mattsson, S., Rääf, C.L., 2014. Household salt for retrospective dose assessments using OSL: signal integrity and its dependence on containment, sample collection, and signal readout. *Radiat. Environ. Biophys.* 53, 559–569.
- Cruz-Zaragoza, E., Barboza-Flores, M., Chernov, V., Melendrez, R., Ramos, B.S., Negron-Mendoza, A., Hernandez, J.M., Murrieta, H., 2006. Optical absorption and thermoluminescence in single NaCl: Cu crystals exposed to ⁶⁰Co and UV light. *Radiat. Prot. Dosim.* 119, 102–105.
- Druzhyina, S., Datz, H., Horowitz, Y.S., Oster, L., Orion, I., 2016. Thermoluminescence

- characteristics of Israeli household salts for retrospective dosimetry in radiological events. *Nucl. Instrum. Meth. B* 377, 67–76.
- Ekendahl, D., Judas, L., 2011. NaCl as a retrospective and accident dosimeter. *Radiat. Prot. Dosim.* 145, 36–44.
- Fuochi, P.G., Alberti, A., Bortolin, E., Corda, U., La Civita, S., Onori, S., 2008. PSL study of irradiated food: NaCl as possible reference material. *Radiat. Meas.* 43, 483–486.
- Herut, B., Gavrieli, I., Halicz, L., 1998. Coprecipitation of trace and minor elements in modern authigenic halites from the hypersaline Dead Sea brine. *Geochim. Acta* 62, 1587–1598.
- Hunter, P.G., Spooner, N.A., Smith, B.W., Creighton, D.F., 2012. Investigation of emission spectra, dose response and stability of luminescence from NaCl. *Radiat. Meas.* 47, 820–824.
- Marcuzzó, J., Cruz-Zaragoza, E., Moreno, E., 2011. Development of a customized OSL reader for the characterization of irradiated foodstuff. *Book of Abstracts ISSSD, XII International Symposium on Solid State Dosimetry*, pp. 39.
- McKeever, S.W.S., Botter-Jensen, L., Agersnap, L.N., Duller, G.A.T., 1997. Temperature dependence of OSL decay curves: experimental and theoretical aspects. *Radiat. Meas.* 27, 161–170.
- Spooner, N.A., Smith, B.W., Creighton, D.F., Questiaux, D., Hunter, P.G., 2012. Luminescence from NaCl for application to retrospective dosimetry. *Radiat. Meas.* 47, 883–889.
- Thomsen, K.J., Bøtter-Jensen, L., Murray, A.S., 2002. Household and workplace chemicals as retrospective luminescence dosimeters. *Radiat. Prot. Dosim.* 101, 515–518.
- Timar-Gabor, A., Trandafir, O., 2013. On optically stimulated luminescence properties of household salt as a retrospective dosimeter. *Radiat. Prot. Dosim.* 155, 404–409.
- Yukihara, E.G., McKeever, S.W.S., 2011. *Optically Stimulated Luminescence: Fundamentals and Applications*. John Wiley & Sons Ltd.
- Zhang, J.F., Yan, C., Zhou, L.P., 2005. Feasibility of optical dating using halite. *J. Lumin.* 114, 234–240.