

ADVANTAGES AND DISADVANTAGES OF Zry WATER CUTTING

L. Avila Gray^a, M. L. Rosenbusch^b, E. D. Cabanillas^{c*}

^aInstituto Sábato, Universidad General. San Martín

^bCONICET and Gerencia Química Comisión Nacional de Energía Atómica

^cCONICET and Departamento de Combustibles Nucleares, Comisión Nacional de Energía Atómica

* Corresponding author, email: ecabanill@cnea.gov.ar; phone: 54 11 6772 7304, fax: 54 11 6772 7203

Recibido: Diciembre 2012. Aprobado: Marzo 2013.

Publicado: Mayo 2013.

ABSTRACT

We present in this work the effects produced when Zircalloy IV separators for nuclear industry are cut by a waterjet machine with abrasive particles. Residual stresses were observed after the process, while no phase transformations were found. Some abrasive particles appears attached to the surface.

Keywords: water cutting; Zry, defects, surfaces.

VENTAJAS Y DESVENTAJAS DEL CORTE POR AGUA DE Zry

RESUMEN

Presentamos en este trabajo los efectos que se producen en los separadores de las vainas de Zry contenedoras de combustible nuclear para reactores de potencia cuando son maquinados por el método conocido como corte con agua con el aporte de partículas abrasivas. Se observaron tensiones residuales sin encontrar evidencias de transformaciones de fase en el Zry y se reporta la aparición de partículas abrasivas en la superficie de la pieza.

Palabras clave: corte agua, Zry defectos, superficies.

INTRODUCTION

Water cutting process, also known as waterjet/abrasive, waterjet machining (WJM) or hydrodynamic machining, is an industrial method used to cut different kind of materials, either metallic or not, Fig. 1, [1,2]. It consists essentially of a high pressure water flux impinging at high velocity on the material to be cut. The water flux is reduced to a narrow beam by a nozzle, which is scanned over the piece surface describing a two dimensional pattern, Fig. 2; usually with the addition of abrasive particles. The variables connected with this process are: water pressure, water flux, abrasive particles and cutting velocity, which are selected according to the sample material, its thickness and the desired surface finishing.

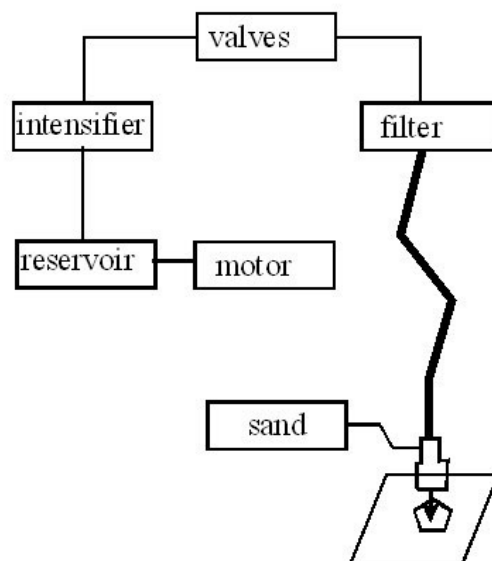

Fig. 1. Experimental device

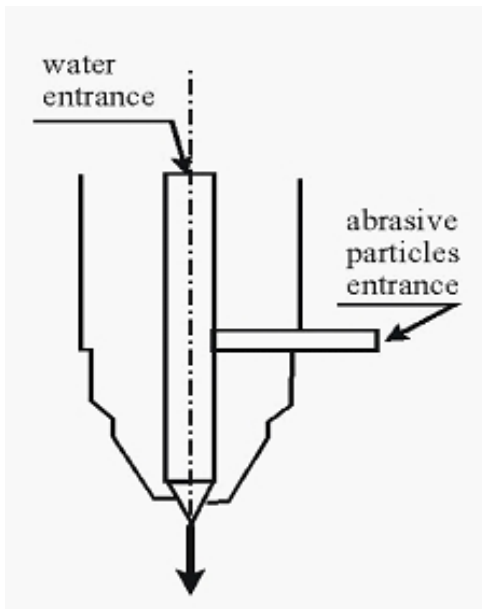

Fig. 2. Nozzle directing water and particles.

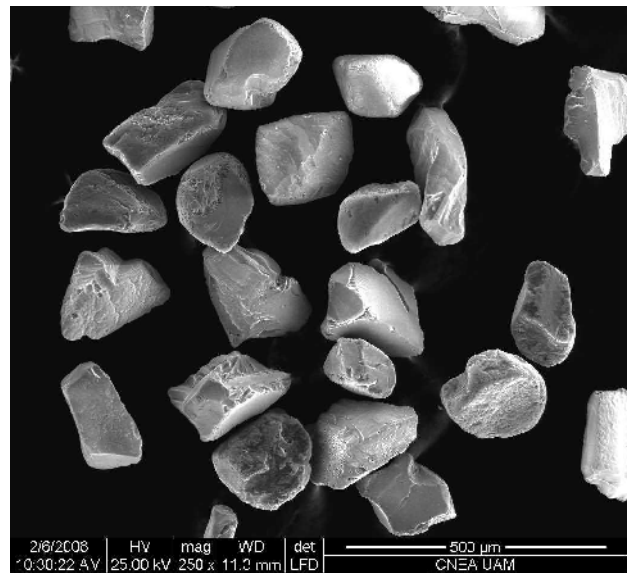

Fig. 3. Abrasive particles.

The zircalloy (Zry) is a trade mark of Zr alloys. Zr has very low absorption cross-section of thermal neutrons (0.18 barn), high hardness, ductility and corrosion resistance, for this reasons is mainly used in nuclear technology, for example as separator of fuel rods in nuclear water power reactors, Fig. 4. The typical composition of nuclear-grade zirconium alloys is more than 95 weight percent zirconium and less than 2 percent of tin, niobium, iron, chromium, nickel, and other metals; added to improve mechanical properties and corrosion resistance. In our case, due to Zry hardness, rhodessite particles were added as abrasive to the water flux. Zry is an alloy of mainly Zr. Some physical properties of the Zry pieces after the cutting process were analyzed and described in the present work.

MATERIALS AND METHODS

We used a MS 2500 WJM TRUMPF machine [3], operating at a water pressure of 3200 bar. A flux of 400 to 420 g/min of rhodessite erosive particles was mixed with water in the nozzle by Bernoulli Effect. The particles were approximately 100 μm in size, with sharp-edged sides, Fig. 3. A cylinder of Zry, 1 cm thick, was water machined to produce the separator, Fig. 4. In the semi-trapezoidal holes, Zry 6 m.

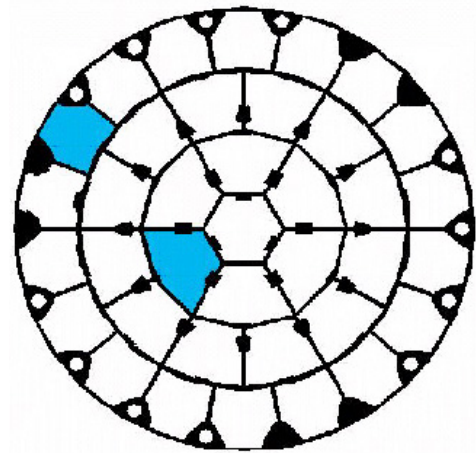

Fig. 4. Nuclear fuel separator, with the trapezoidal holes.

Tubes containing the uranium are 5 m length and 10 mm in diameter and have to be fixed and separated each other by this piece and have to resist the reactor heavy water flux at high temperatures. The separators were usually made by electro discharge machining (EDM) with Cu or graphite electrodes, requiring a large processing and handling time and implying an important environmental danger, because the removed material, composed of debris of Zr and carbon has to be later disposed [4,5].

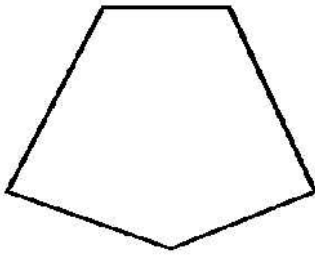

Fig. 5. Trapezoidal piece.

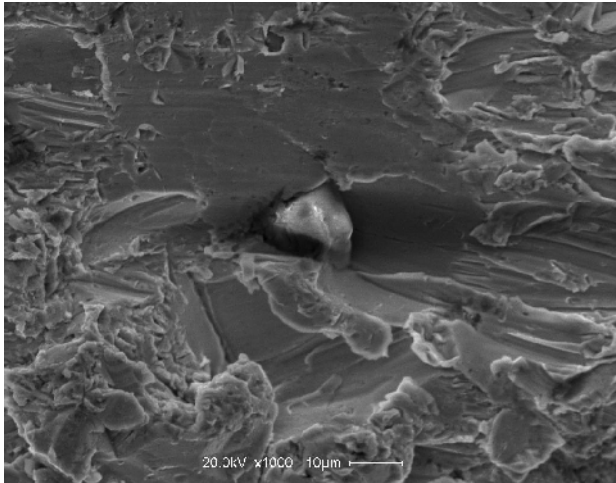

Fig. 6. Surface panorama with an adhered particle.

In our case when the water and particles flux produces a trapezoidal channel, the discarded piece is rescued and remelted allowing in this way the amortization of the WJM in few years. We have selected for our observations the trapezoidal "discarded" pieces instead of the separator itself, because it was easier to observe the external surface rather than the cavity.

Some physical properties of the Zry pieces after the cutting process were compared by different experimental methods: optical microscopy (OM), scanning electron microscopy (SEM), energy dispersive spectroscopy (EDS), back scattered electrons spectrometry (BSE), x-ray residual stress analysis as well as roughness and hardness measurements.

RESULTS AND DISCUSSION

In Fig. 5, it is shown the scheme of the studied trapezoidal pieces. The surface of samples cut by this method is shown

in Fig. 6 where it can be seen an adhered abrasive particle on the specimen surface. EDS indicated the rhodosite composition being Mg, Al, Si, Ca and Fe.

The residual stress was -200 MPa , as determined by a Philips X Pert MRD Equipment. Roughness was evaluated by an Mitutoyo, SurfTest SV-400 model equipment. Three scanings of $2,5\text{ mm}$ each, at $0,5\text{ mm/s}$ velocity with a deflection of amplitude of $80\text{ }\mu\text{m}$ gave the results shown in Table I which also shows some experimental parameters included. No differences in hardness before and after the process were observed. The average hardness was 22.5 N/mm^2 . We have observed particles adhered after sonication on the sample surface, as shown in Fig. 6, EDS analysis proved that they are fragments of the abrasive particles, Fig. 7.

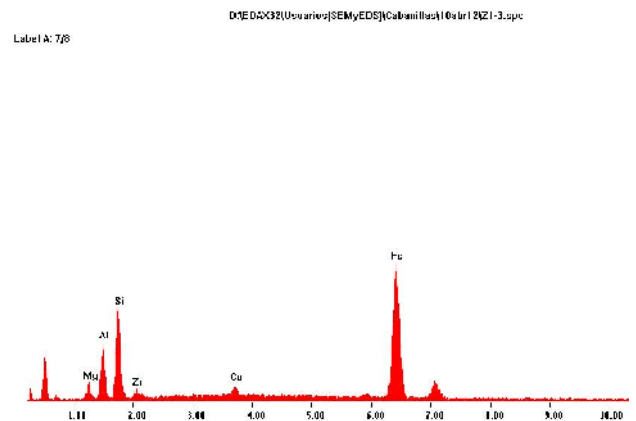

Fig. 7. EDS of adhered particle of Fig. 6.

Table 1. Roughness results.

L	2.50	mm	Scan Length
N	3.00		N° of scans
Ra	1.79	μm	Profile medium average.
Rq	2.30	μm	Profile RMS value.
Ry	13.27	μm .	Maximum height from 0 level
Rt	14.40	μm	Distance from bottom, 3 scans largest data.
Pc	58.70	1/cm	N° of peaks per cm above 5 % from maximum

The high energy particles flux impinging on a small area, generates a high pressure reaching the material rupture tension and produces the material separation in small debries. In this way the WJM process, is similar to the cut metal machining, where the cut tool scratches chips or produces curls of metal from the piece. But the debries are quite different. In the WJM are about 100 nm to 150 μm in size [6] and in the conventional cut tool process are curls of several mm in size. Fast heating occurs when abrasive particles knock onto the surface, while the water flux at room temperature produces the opposite effect of fast cooling. In this Zry material we observed some intense light produced by Zr oxidation during the WJM. There is a relationship between particle size and the resultant marks on the Zry sample, scratches are one or two orders lower in magnitude than abrasive particles, indicating that the sharp edged particles interact with the specimen in small areas. The roughness measurements give a numerical data related with the scratch dimensions. The hardness measurements give evidence that no relevant modifications have occurred. The residual stress determined by X-ray diffraction corresponds to a normal compression effect with a value of -200 Mpa. No evidence of phase transformation was observed in this case by the X-ray diffraction stress determination.

CONCLUSIONS

- 1) Abrasive particles remain adhered to the piece surface. This is important if the discarded metal piece will be melted later, because these particles could modify the chemical composition of the alloy.
- 2) Residual stresses are produced by this cutting process.
- 3) No hardness changes have been noticed.
- 4) No phase transformations were found.

ACKNOWLEDGMENTS

To the Materials Department of CNEA for the SEM and EDS analysis.

To PICT 01165 of the Agency for research and innovations and Dr. N. Mingolo for the residual stresses measurements.

REFERENCES

- [1] Johnston C.E., (1989) *Waterjet/Abrasive Waterjet Machining*, Metals Handbook, 9th ed. Vol. 9, pp. 520-527.
- [2] Vhymeister A.F., Fuentes M. (2004) "Corte mediante chorro de agua-abrasivo" *Síntesis Tecnológica*. 1:36-38.
- [3] Reference Book of TRUMPF WS 2500 machine.
- [4] Cabanillas, E.D., Desimoni, Punte G., and Mercader R.C., (2000) "Formation of carbides by electro-discharge machining of alpha iron" *Mat. Sci. Eng. A*. 276: 133-140.
- [5] Cabanillas E.D., Pasqualini E.E., Desimoni J., Mercader R.C., López M. and Cirilo D. (2001) "Morphology and phase composition of particles produced by electro-discharge-machining of iron" *Hyperfine Interactions* 134:179-185.
- [6] Cabanillas E.D. (2010) "Micro and Nano Particles Produced by Waterjet Abrasion" *Acta Microscopica* 19 (1): 105-108.