



Disruption of thalamocortical activity in schizophrenia models: relevance to antipsychotic drug action

Pau Celada^{1,2,3}, Laia Lladó-Pelfort^{1,2,3}, N. Santana^{1,2,3}, L. Kargieman^{1,2,3},
Eva Troyano-Rodriguez^{1,2,3}, M. S. Riga^{1,2,3} and Francesc Artigas^{1,2,3}

¹ Department of Neurochemistry and Neuropharmacology, Institut d'Investigacions Biomèdiques de Barcelona, (IIBB-CSIC), Barcelona, Spain.

² Centro de Investigación Biomédica en Red de Salud Mental (CIBERSAM), Spain

³ Institut d'Investigacions Biomèdiques August Pi i Sunyer (IDIBAPS), Barcelona, Spain

Abstract

Non-competitive NMDA receptor antagonists are widely used as pharmacological models of schizophrenia due to their ability to evoke the symptoms of the illness. Likewise, serotonergic hallucinogens, acting on 5-HT_{2A} receptors, induce perceptual and behavioural alterations possibly related to psychotic symptoms. The neurobiological basis of these alterations is not fully elucidated. Data obtained in recent years revealed that the NMDA receptor antagonist phencyclidine (PCP) and the serotonergic hallucinogen 1-(2,5-dimethoxy-4-iodophenyl)-2-aminopropane; (DOI) produce a series of common actions in rodent prefrontal cortex (PFC) that may underlie psychotomimetic effects. Hence, both agents markedly disrupt PFC function by altering pyramidal neuron discharge (with an overall increase) and reducing the power of low frequency cortical oscillations (LFCO; <4 Hz). In parallel, PCP increased *c-fos* expression in excitatory neurons of various cortical areas, the thalamus and other subcortical structures, such as the amygdala. Electrophysiological studies revealed that PCP altered similarly the function of the centromedial and mediodorsal nuclei of the thalamus, reciprocally connected with PFC, suggesting that its psychotomimetic properties are mediated by an alteration of thalamocortical activity (the effect of DOI was not examined in the thalamus). Interestingly, the observed effects were prevented or reversed by the antipsychotic drugs clozapine and haloperidol, supporting that the disruption of PFC activity is intimately related to the psychotomimetic activity of these agents. Overall, the present experimental model can be successfully used to elucidate the neurobiological basis of schizophrenia symptoms and to examine the potential antipsychotic activity of new drugs in development.

Received 14 March 2013; Reviewed 3 April 2013; Revised 10 May 2013; Accepted 10 May 2013;

First published online 1 July 2013

Key words: 5-HT receptors, antipsychotic drugs, NMDA receptors, prefrontal cortex, thalamus.

Introduction

Schizophrenia is a severe psychiatric disease affecting about 1% of the world population. It has an early onset (typically late adolescence or early adulthood) and shows a chronic and deteriorating course. Affected individuals have a lifelong disability and nearly 10% commit suicide. Schizophrenia is characterized by a variety of symptoms, including positive

(hallucinations, delusions, disorganized speech, aberrant behaviour etc.) and negative symptoms (depression, anxiety, emotional blunting, social withdrawal etc.) as well as cognitive dysfunction. Anatomical, cellular and neurochemical alterations have been reported in various brain areas of schizophrenic patients and notably in the prefrontal cortex (PFC; Harrison, 1999; Selemon and Goldman-Rakic, 1999; Lewis and Lieberman, 2000; Harrison and Weinberger, 2005; Lewis and Gonzalez-Burgos, 2006; see later for extended information). Likewise, anatomical and functional abnormalities of the thalamus have also been reported in schizophrenia (Jones, 1997; Clinton and Meador-Woodruff, 2004; Alelu-Paz and

Address for correspondence: Dr F. Artigas, Department of Neurochemistry and Neuropharmacology, IIBB-CSIC (IDIBAPS), Rosselló, 161, 6th floor, 08036 Barcelona, Spain. Tel.: +3493 363 8315 Fax: +3493 363 8301 Email: fapnqi@iibb.csic.es

Gimenez-Amaya, 2008; Watis et al., 2008; Vukadinovic, 2011; Vukadinovic and Rosenzweig, 2012) and alterations in thalamic circuits have been suggested to be involved in the emergence of psychotic symptoms (Lisman et al., 2010).

Here we review data produced by our group and others supporting the involvement of the PFC and related thalamic nuclei (centromedial and mediodorsal) in (a) the mechanism of action of psychotomimetic drugs, in particular *N-Methyl-D-aspartate* (NMDA) receptor antagonists and serotonin [5-hydroxytryptamine (5-HT)]_{2A} receptor agonists and (b) the therapeutic action of antipsychotic drugs.

Prefrontal cortex and schizophrenia: an overview

The PFC plays an important role in the pathophysiology and treatment of schizophrenia. The PFC has poorly defined anatomical boundaries although it is defined by its reciprocal connectivity with the mediodorsal nucleus of the thalamus. The PFC is involved in many higher brain functions such as perception, attention, memory, language, intelligence, consciousness, affect etc. The dorsolateral PFC plays a key role in cognitive processes such as working (short-term) memory and executive functions as well as in action planning and decision making (Fuster, 2001, 2008; Miller and Cohen, 2001). In addition to cognitive functions, the PFC is involved in the control of mood and affect. Hence, the ventromedial PFC, or ventral cingulate cortex, is deeply involved in emotional processing (Devinsky et al., 1995; Davidson and Irwin, 1999; Cardinal et al., 2002; Phillips et al., 2003) and psychotic symptoms such as hallucinations are associated with hyperactivity of this PFC subdivision (Shergill et al., 2000).

Similarly to other cortical areas, the PFC is composed of ~75–80% of pyramidal projection neurons, which use glutamate as a transmitter and ~20–25% of local circuit inhibitory interneurons that use GABA as a transmitter. Pyramidal neurons integrate excitatory glutamatergic afferent inputs from various thalamic nuclei, including the mediodorsal, centromedial and several midline nuclei, the hippocampus, the amygdala and the rest of cortical areas to which it is connected (Groenewegen and Uylings, 2000; Fuster, 2008). Local inhibitory inputs arise from GABAergic interneurons. These have been classified according to anatomical and neurochemical characteristics and to their synaptic relationships with pyramidal neurons (Defelipe et al., 2013). Among them, large perisomatic, parvalbumin-containing neurons such as the chandelier and basket cells, play a major

role in controlling excitatory pyramidal output by targeting GABA_A receptors located in the cell bodies and initial segments of pyramidal axons (Defelipe et al., 1989). This peculiar connectivity allows for a direct inhibitory control of the generation of nerve impulses by pyramidal neurons. Cortical parvalbumin-containing GABA interneurons have been suggested to play a role in schizophrenia symptoms; in particular, in cognitive control (Lewis et al., 2005, 2012).

Likewise, PFC neurons receive a dense innervation from the brainstem monoaminergic nuclei [dorsal and median raphe nuclei, locus coeruleus and ventral tegmental area, which employ 5-HT, noradrenaline and dopamine (DA) as main neurotransmitters, respectively]. These neuronal groups exert an important modulatory role of the excitatory and inhibitory currents in PFC neurons (Steinbusch, 1981; Vaneden et al., 1987; Seamans and Yang, 2004; Aston-Jones and Cohen, 2005; Puig et al., 2005; Celada and Artigas, 2007). A large population of pyramidal and GABAergic neurons in PFC express receptors sensitive to monoamine neurotransmitters in mammalian brain (Santana et al., 2004, 2009, 2012; de Almeida and Mengod, 2007, 2008). Atypical antipsychotic drugs such as clozapine (CLZ) show high affinity for these monoamine receptors (in particular 5-HT_{2A/2C}, 5-HT_{1A} and α -adrenoceptors, and to a lesser extent, DA D₂ receptors), suggesting that the PFC is a key brain structure in their therapeutic action, in addition to the well-known blockade of DA D₂ receptors in the ventral striatum (Artigas, 2010).

NMDA receptors; non-competitive antagonists

Strong (ionic) actions of glutamate are mediated by three receptor subtypes, namely the (AMPA), kainate and NMDA receptors. These receptors are ion channels, whose activation by glutamate allows extracellular Na⁺ and Ca²⁺ ions to enter (and K⁺ ions to leave) the neuronal cytoplasm, thus evoking rapid and marked changes of the membrane potential (depolarization in most instances) which subsequently allow for the generation of action potentials. Glutamate can also act on a family of eight G-protein coupled metabotropic receptors, analogous to monoamine receptors, which are suitable targets for drug development in various fields of psychiatry (Swanson et al., 2005; Niswender and Conn, 2010).

NMDA receptors are involved in a large number of key physiological functions, such as long-term potentiation and synaptic plasticity, and play a role in several neurological and psychiatric disorders (Lau and Zukin, 2007; Paoletti and Neyton, 2007). NMDA

receptors are tetrameric ion channels composed of two NR1 and two NR2 (A, B, C, D) subunits. A third type of NMDA subunits (NR3, A and B) has been identified and it changes the ionic sensitivity of the NMDA channel (Cavara and Hollmann, 2008). The NMDA receptor ion channel is voltage-sensitive, i.e. the channel is blocked by Mg^{2+} ions in resting conditions. Only after the depolarization of the cell membrane, Mg^{2+} ions are released to allow for the passage of other ions (Na^+ , Ca^{2+} , K^+) through the channel. Thus, in general, AMPA-induced depolarization precedes the functional activity of NMDA receptors.

The NMDA receptor contains several binding sites, including the site for glutamate and competitive antagonists such as AP5 (or AP-V). Likewise, it contains several regulatory sites, such as the glycine site, outside the channel and the Mg^{2+} and the non-competitive antagonist site [also called phencyclidine (PCP) site], inside the channel. The dissociative anaesthetics ketamine and PCP are non-competitive NMDA receptor antagonists. These agents have been used as a pharmacological model of schizophrenia due to their ability to evoke positive and negative symptoms of schizophrenia in healthy individuals and to aggravate them in schizophrenic patients (Javitt and Zukin, 1991; Krystal et al., 2003). Moreover, PCP, ketamine and dizocilpine (MK-801; not available for human use) evoke a series of behavioural alterations in experimental animals characterized by hyperlocomotion, stereotypies and disruption in pre-pulse inhibition of the startle response. These alterations are totally or partly antagonized by antipsychotic drugs (Carlsson and Carlsson, 1989; Geyer et al., 2001). However, the cellular elements and brain networks involved in these actions are still poorly known, although work by different research groups in recent years has started to clarify the actions of NMDA receptors antagonists on PFC function.

Effects of non-competitive NMDA receptor antagonists on neuronal activity in thalamocortical networks

The PFC appears as a target area for these actions since neuroimaging studies show that PCP and ketamine increase PFC activity (Breier et al., 1997). The i.v. administration of PCP to anaesthetized rats exerts a complex effect on the discharge rate of pyramidal neurons of the medial PFC (mPFC), identified by antidromic activation from midbrain (Kargieman et al., 2007). PCP (0.25 mg/kg i.v.) increased the discharge rate of 45% of the recorded neurons (to 286% of baseline), reduced the discharge of 35% (to 43% of baseline)

and left unaffected the rest (22%). Figure 1 shows an example of a PFC pyramidal neuron excited by PCP. Burst firing was affected in a similar manner (Table 1).

Likewise, the administration of PCP (0.25 mg/kg i.v.) altered the discharge of thalamic neurons projecting to the mPFC, in the centromedial and mediodorsal nuclei increasing (to 424% of baseline) and decreasing (to 41% of baseline) the activity of 57 and 20% of the recorded neurons, respectively (23% remained unaffected; Santana et al., 2011). Figure 1c shows a representative example of the effect of PCP on a thalamic neuron. Figure 2 shows the comparison of the effect of PCP on the discharge rate of pyramidal neurons in mPFC and of thalamic relay neurons in the centromedial and mediodorsal nuclei, reciprocally connected with the mPFC (Berendse and Groenewegen, 1991; Kuroda et al., 1998; Gabbott et al., 2005).

Double *in situ* hybridization experiments revealed that PCP (10 mg/kg i.p.) markedly increased *c-fos* expression in glutamatergic neurons of several cortical areas (prefrontal, somatosensory, retrosplenial, entorhinal; Santana et al., 2011). PCP also induced a very marked increase of *c-fos* expression in various thalamic nuclei, in particular the centromedial and mediodorsal nuclei. PCP also increased *c-fos* expression in the amygdala and had a small effect in the hippocampal formation of the same animals (Figs 1 and 3).

Recent evidence from other groups also supports the involvement of thalamic nuclei in the action of NMDA receptor antagonists. Hence, ketamine administration increased the discharge rate in the nucleus reuniens of the thalamus and subsequently, in the cornu ammonis 1 (CA1) subfield of the hippocampus, to which the nucleus reuniens projects (Zhang et al., 2012). The same team also reported that NMDA receptor blockade with the competitive antagonist AP-V in the reticular thalamic nucleus evoked bursts of δ oscillations (Zhang et al., 2009). Moreover, the effect of systemic MK-801 administration on slow oscillations (see later) in the PFC was mimicked by the local application of lidocaine in the mediodorsal nucleus of the thalamus (Kiss et al., 2011a). Furthermore, the motor hyperactivity and behavioural stereotypies induced by MK-801 in rats were prevented by the local (bilateral) application of the GABA_A agonist muscimol in the anterior nucleus of the thalamus, suggesting that MK-801 reduces GABA_A-mediated neurotransmission in the thalamus (Hill and Scorza, 2012). Overall, these observations clearly support the implication of thalamic nuclei in the behavioural, perceptual and possibly cognitive alterations induced by non-competitive NMDA receptor antagonists.

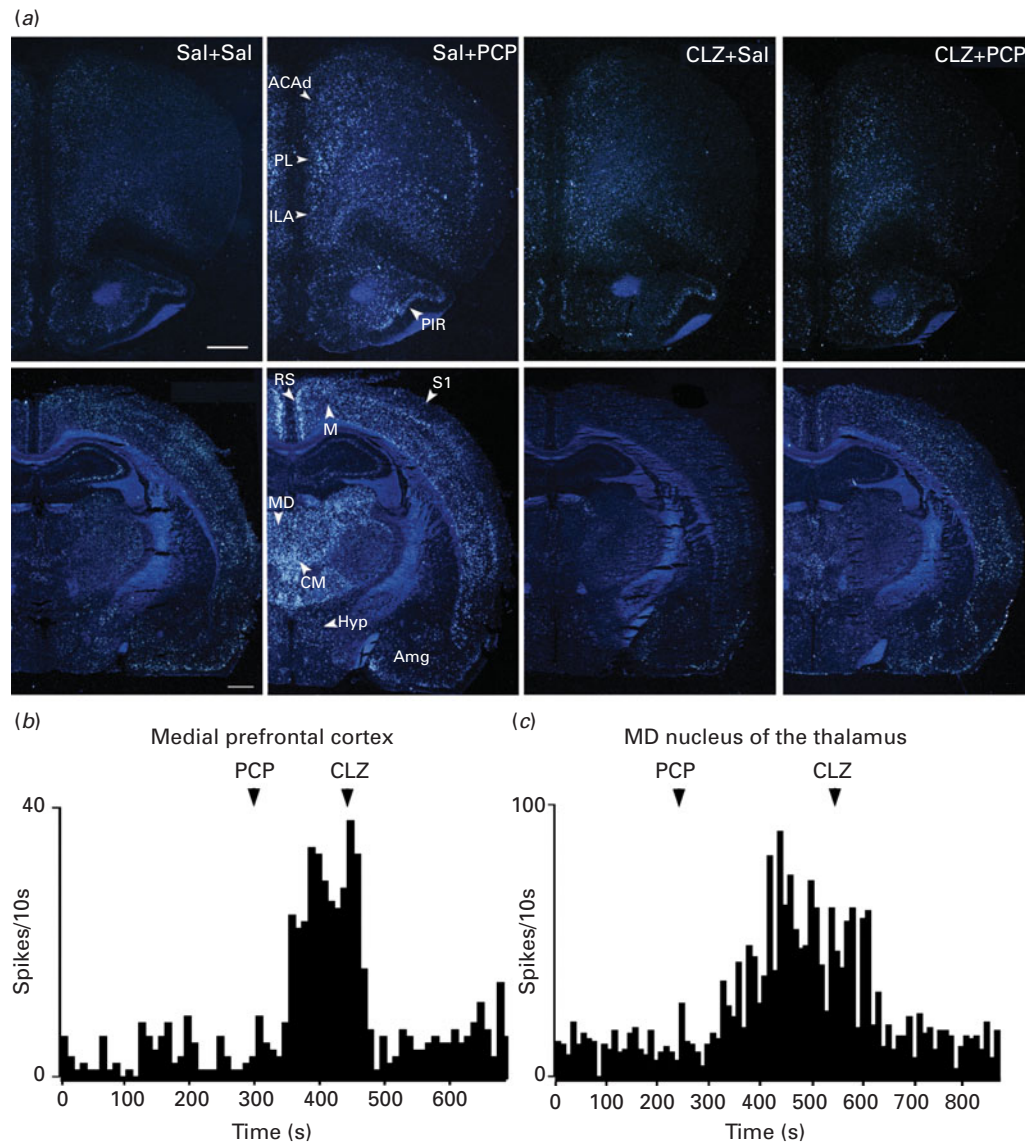

Fig. 1. Effect of phencyclidine (PCP) administration on the activity of thalamocortical networks in rat brain. (a) Macroscopic dark-field images from emulsion-dipped coronal sections at two different anteroposterior (AP) coordinates from control and treated rats showing the localization of cells expressing *c-fos* messenger RNA (mRNA). Upper row correspond to AP+3.7 mm and lower row to AP -2.5 mm from bregma. Columns correspond to the treatments indicated in the figure (Sal, saline; PCP, phencyclidine 10 mg/kg i.p.; CLZ, clozapine 5 mg/kg i.p.). Note the marked expression of *c-fos* mRNA in various cortical and thalamic areas of PCP-treated rats together with the relative absence of a significant increase in hippocampal areas. In prefrontal cortex, a particularly remarkable increase was observed in dorsal anterior cingulate, prelimbic and infralimbic areas. ACAAd, dorsal anterior cingulate; CM, central medial thalamic nucleus; Hyp, hypothalamus; ILA, infralimbic area of prefrontal cortex; M, motor cortex; MD, mediodorsal thalamic nucleus; PIR, piriform cortex; PL, prelimbic cortex; RS, retrosplenial cortex; S1, somatosensory cortex. Bar: 1 mm. Panels (b) and (c) show extracellular recordings of a pyramidal and thalamic neuron showing the effect of PCP (0.25 mg/kg i.v.) on the discharge rate. Note the marked increase of the discharge produced by PCP in both neurons, as well as the reversal of this effect by the subsequent administration of CLZ (1 mg/kg i.v.). Arrows mark the time of injections (abscissa in s).

Table 1. Effect of phencyclidine (PCP) on pyramidal cell activity in the medial prefrontal cortex

	Group	Basal	PCP (0.25 mg/kg)
Firing rate (spikes/s)	A	2.2±0.3	3.4±0.4*
	E	2.1±0.3	6.0±0.7**
	I	2.8±0.8	1.2±0.4**
Spikes in bursts (2 min)	A	177±36	238±35
	E	117±25	386±61**
	I	288±99	100±37*
Burst episodes (2 min)	A	72±12	101±14
	E	54±11	169±24**
	I	109±31	39±12*
<i>n</i>	A	80	80
	E	36	36
	I	26	26

A, All neurons; E, excited neurons; I, inhibited neurons.

* $p < 0.05$, ** $p < 0.01$, vs. baseline.

PCP action on corticothalamic or thalamocortical pathways?

Despite these marked alterations of PFC function induced by PCP, it is still unclear whether NMDA receptor antagonists primarily affect PFC or whether other cortical and subcortical areas reciprocally connected with the PFC are also involved, in particular the hippocampal formation and the thalamus. The opposite effects of the systemic MK-801 administration on the activity of putative pyramidal and GABAergic neurons (increase and decrease, respectively) led to the proposal of a preferential blockade of NMDA receptors on cortical GABAergic interneurons and a subsequent disinhibition of pyramidal neurons (Jackson et al., 2004; Homayoun and Moghaddam, 2007). However, the local application of PCP or MK-801 in mPFC reduced the discharge of putative pyramidal neurons (Suzuki et al., 2002; Jodo et al., 2005) and the study by Jodo et al. (2005) reported a facilitation of pyramidal neuron activity in mPFC by the local application of PCP in the hippocampal formation. Moreover, the systemic, but not local, administration of non-competitive NMDA receptor antagonists increased neurotransmitter release in PFC (Amargos-Bosch et al., 2006; Lopez-Gil et al., 2007) suggesting that NMDA receptor blockade in other brain areas may also contribute to increased PFC activity.

These electrophysiological and histological observations suggest the involvement of cortical and thalamic areas in the action of PCP, with a minor contribution of the hippocampal formation, as judged

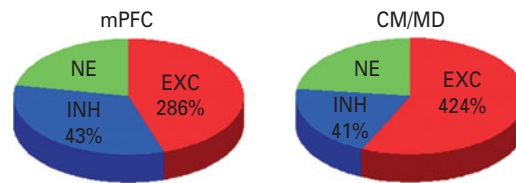

Fig. 2. Comparison of the effect of phencyclidine (PCP, 0.25 mg/kg i.v.) on the discharge rate of pyramidal neurons in medial prefrontal cortex (mPFC) and relay neurons of the centromedial and dorsomedial nuclei of the thalamus (CM/MD). Each colour sector corresponds to one of the three neuronal responses to PCP (excitations, EXC; inhibitions, INH, no effect, NE). The percentage inside each sector shows the average magnitude of the effect; $n=80$ for PFC and $n=50$ for CM/MD (one neuron per rat). Data reproduced from Kargieman et al. (2007) and Santana et al. (2011).

from *c-fos* experiments. Given the reciprocal connectivity of PFC with the centromedial and mediodorsal nuclei of the thalamus, PCP effects may be interpreted as resulting from a primary action of PCP on cortical (*a*, top-down) or thalamic targets (*b*, bottom-up), as follows. (*a*) top-down: PCP would mainly block NMDA receptor inputs onto PFC GABAergic interneurons, as shown for MK-801 (Homayoun and Moghaddam, 2007), thus disinhibiting pyramidal neurons and increasing corticothalamic inputs. Likewise, 2-d ketamine treatment reduced GABAergic markers and inhibitory synaptic transmission in PFC (Zhang et al., 2008). (*b*) bottom-up: PCP blocks NMDA receptor inputs onto GABAergic neurons in basal ganglia (ventral pallidum, substantia nigra reticulata) and/or the reticular nucleus of the thalamus (Rt); this effect would disinhibit thalamic relay neurons and would increase thalamocortical inputs. Both interpretations are not mutually exclusive and may simultaneously occur (Fig. 4).

A putative effect of PCP on hippocampal-PFC neurons appears unlikely to explain the PCP-induced changes in PFC since PCP had a minimal effect on *c-fos* expression in the various hippocampal subfields [CA1, CA3, somatosensory cortex (S)], as previously observed (Santana et al., 2011; see also Fig. 3). Alternatively, *c-fos*-expressing cells in the CA1 subfield are GABAergic (Santana et al., 2011), an observation discordant with a putative increase of the hippocampal excitatory output to mPFC.

Despite the overall excitatory effect of PCP and MK-801 on PFC pyramidal neurons (Jackson et al., 2004; Jodo et al., 2005; Kargieman et al., 2007) and the top-down control exerted by PFC on subcortical structures (Miller and Cohen, 2001), it seems unlikely

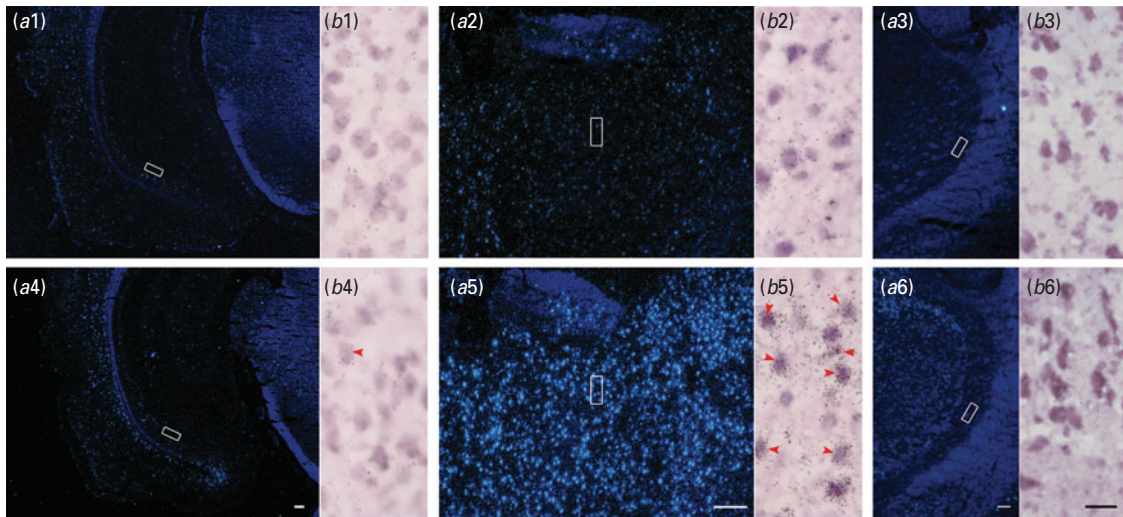

Fig. 3. Effect of phencyclidine (PCP) on *c-fos* expression in hippocampal and thalamic areas. Macroscopic dark-field images from emulsion-dipped coronal sections at anteroposterior coordinate approximately -6.3 mm from bregma (*a1* and *a4*, showing ventral hippocampus) and -3.6 mm from bregma [*a2*–*a6*, showing mediodorsal nucleus of the thalamus (MD; *a2* and *a5*) and reticular nucleus of the thalamus (Rt; *a3* and *a6*)]. Upper row correspond to saline- and lower row to phencyclidine (PCP)-treated rats. Note the occurrence of a low number of *c-fos* positive cells in the ventral subiculum (VS)/cornu ammonis (CA)1 area of the hippocampus and Rt of PCP treated rats and the high number of cells expressing it in MD. (b) High magnification photomicrographs of VS (*b1* and *b4*), MD (*b2* and *b5*) and Rt (*b3* and *b6*) showing the detection of *c-fos* mRNA using ^{33}P -labelled oligonucleotides (silver grains) in glutamatergic (vGluT1-positive; *b1*–*b5*) or GABAergic (GAD65/67-positive; *b3* and *b6*) neurons (digoxigenin-labelled oligonucleotides, dark precipitates). Red arrowheads mark some double-labelled cells. Note the high number of cells expressing *c-fos* mRNA in MD of PCP-treated rats compared with VS/CA1 and Rt. Open rectangles show the approximate location where photomicrographs were taken. Scale bars: (a) $200\ \mu\text{m}$; (b) $20\ \mu\text{m}$.

that the increase in PFC activity can solely drive the massive *c-fos* expression observed in cortical and thalamic areas as well as the marked increase in thalamic discharge. Thalamic relay cells are subjected to direct monosynaptic corticothalamic excitatory inputs plus bisynaptic, reticular nucleus-mediated, feed-forward inhibitions (Steriade, 2001; Jones, 2002). Nearly 70% of excitatory synapses on Rt cells are from corticothalamic fibres (Jones, 2002). Thus, under certain conditions, the cortex can exert an inhibitory influence over the thalamus via Rt-mediated inhibitions (Steriade, 2001). This suggests that a PCP-mediated activation of PFC should result in a more moderate effect in thalamic neurons from the centromedial and mediodorsal nuclei than that observed (Fig. 2). Moreover, given the corticothalamic connectivity (see earlier), a PFC-driven increase of thalamic activity should have also activated *c-fos* expression in GABA cells of the reticular nucleus.

A bottom-up (e.g. thalamocortical) increase of cortical activity may also contribute to the overall activation of cortical and thalamic regions. PCP did not increase *c-fos* expression in the reticular nucleus (Fig. 3) nor in basal ganglia such as the substantia nigra reticulata

or ventral pallidum, which send inhibitory afferents to thalamic relay neurons. Alternatively, PCP markedly increased *c-fos* expression in layers IV and VI of S1, indicating the existence of an increased thalamocortical (layers IV and VI) and corticothalamic (layer VI) functional connectivity [see Shipp (2007) for review of thalamocortical connectivity]. Likewise, PCP increased *c-fos* in a narrow band of cells between layers III and V in PFC (Kargieman et al., 2007) which receive thalamic inputs (Kuroda et al., 1998), since the rat PFC lacks layer IV. Interestingly, unlike in PFC (Kargieman et al., 2007), GABAergic neurons in S1 and retrosplenial cortices expressed *c-fos* in response to PCP treatment, which agrees with the dual projection of thalamocortical fibres to cortical glutamatergic and GABAergic neurons (Sun et al., 2006) and the preferential thalamocortical inputs on fast-spiking cortical interneurons (Hull et al., 2009).

Irrespective of the primary target area(s) affected by PCP, its overall excitatory effects on thalamocortical pathways is clearly indicative of a preferential action on NMDA receptors located on inhibitory GABAergic neurons. The reason(s) for this cellular selectivity are unclear and may involve a different

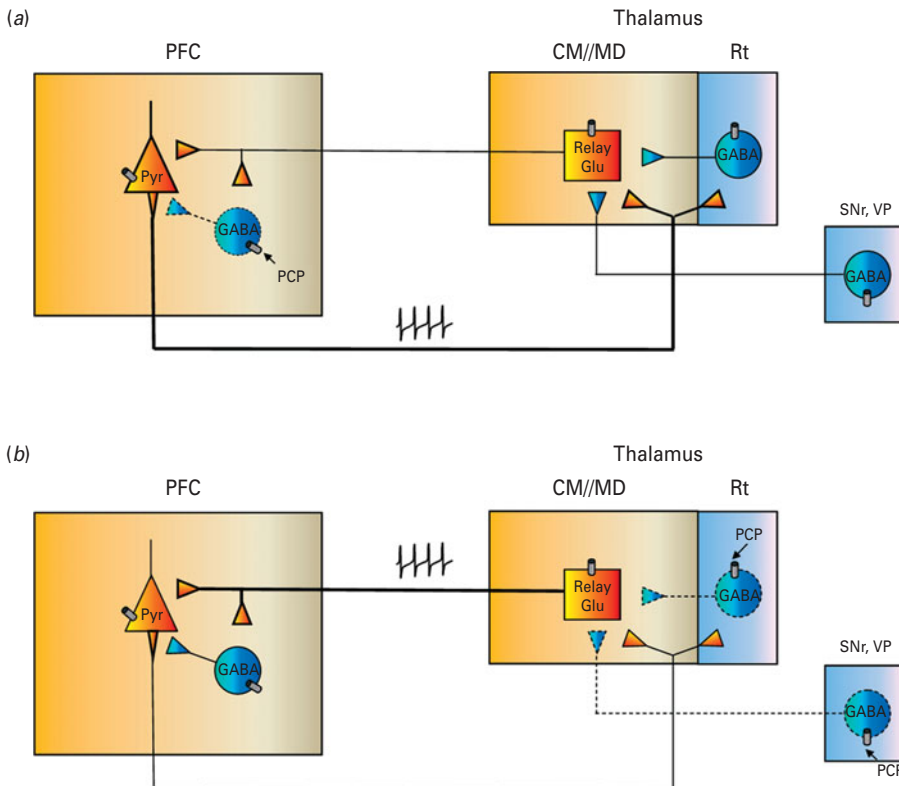

Fig. 4. Schematic representation of two potential sites of action of phencyclidine (PCP) on *N*-methyl-D-aspartate receptor (NMDAR) in cortical and subcortical GABAergic neurons. (a) PCP blockade of NMDAR in fast-spiking cortical GABAergic interneurons would reduce tonic GABA_A-mediated inputs onto prefrontal cortex (PFC) pyramidal (Pyr) neurons. Given the widespread projections of PFC pyramidal neurons to many subcortical areas (including the thalamus), the increase in pyramidal discharge would result in an enhanced excitatory input onto thalamic neurons. (b) PCP blockade of NMDAR in inhibitory inputs to glutamatergic thalamic nuclei [e.g. reticular nucleus (Rt), substantia nigra reticulata (SNr) or ventral pallidum (VP)] would disinhibit thalamic relay neurons leading to increased excitatory thalamocortical inputs in various cortical areas. The relative weight of options *a* and *b* in the overall effects of PCP may differ among cortical areas. CM//MD, centromedial and dorsomedial nuclei of the thalamus; GABA, Modified from Santana et al. (2011).

subunit composition of the NMDA receptor (Monyer et al., 1994; Wenzel et al., 1997; Karavanova et al., 2007) which would confer different pharmacological properties from other regions rich in excitatory neurons. In support of this possibility, the competitive NMDA receptor antagonist AP-5 hyperpolarized Rt cells, but not PFC cells, *in vitro* (Zhang et al., 2009). An alternative explanation lies on the mechanism of action of non-competitive NMDA receptor antagonists, including PCP. These agents require the release of Mg²⁺ ions to penetrate the NMDA channel. Hence, PCP may preferentially block NMDA receptor inputs on fast-spiking GABA neurons (e.g. cortical interneurons, Rt neurons or basal ganglia projection neurons), which are depolarized for more prolonged periods of time than PFC pyramidal or thalamic relay neurons, which fire at lower rates. Further work is required to examine this possibility.

Brain oscillations: relevance to schizophrenia

Higher cognitive functions and executive functions emerge from the coordinated activity of different neuronal networks and brain areas. This is reflected in an oscillatory activity, a characteristic feature of cortical dynamics. Brain oscillations can be evidenced through electroencephalographic (EEG) recordings which detect the integrated activity of neuronal networks surrounding the electrodes (Nunez and Srinivasan, 2006). EEG oscillatory activity depends on the synchrony at which local and distal networks operate. Since the discovery of the EEG by Berger (1929) and the first description of the most prominent rhythm (α , 8–12 Hz), multiple oscillatory activities have been described: slow (<1 Hz); δ (1–4 Hz); θ (4–7 Hz); β (12–30 Hz); γ (30–80 Hz) oscillations. Brain oscillations are important in codifying neural

Table 2. Oscillatory activity in animal models of schizophrenia

Model	Studied parameters	Effects	Reference
Pharmacological NMDA hypofunction	FC and sensorimotor cortex EEG power in conscious rats	PCP and MK-801 ↑ FC 1–3 Hz power and ↑ or ↓ 9–30 Hz power depending on dose	Sebban et al. (2002)
	mPFC pyramidal neuron firing and low frequency cortical oscillations power in anesthetized animals	PCP increases pyramidal firing and decreases low frequency oscillations	Kargieman et al. (2007) Kargieman et al. (2012)
	Hippocampal EEG in freely moving rats	Ketamine and MK-801 ↑ hippocampal γ power Antagonized by pre-perfusion of muscimol into the medial septum or supramammillary area.	Ma and Leung (2007)
	Neocortical spontaneous γ oscillations in freely moving rats	Ketamine and MK-801 ↑ γ power	Pinault (2008)
	<i>In vivo</i> recordings from CA3 regions of mouse during a paired-click auditory task	Ketamine ↓ θ frequency band in background activity and in poststimulus evoked activity	Lazarewicz et al. (2010)
	Interactions between high and low-frequency γ oscillations in layers III and V of rat visual cortex <i>in vitro</i>	Ketamine, PCP, selective NR2B subunit-containing receptor antagonism and reduced D-serine levels caused cross-layer phase coupling of γ oscillations	Anver et al. (2011)
	Oscillatory activity in hippocampus, dorsal striatum and nucleus accumbens	Ketamine ↑ high frequency oscillations power in all structures, ↑ γ oscillations in hippocampus and ↓ in nucleus accumbens	Hunt et al. (2011)
	Subiculum stimulation, MUA and local field potential recordings of mPFC in urethane-anaesthetized rats	Systemic and local microinjections of MK-801 in MD changed 2 Hz oscillation to a less regular δ rhythm ↓ paired-pulse facilitation, ↓ overall MUA	Kiss et al. (2011a, b)
	Mediodorsal and centromedial thalamic single unit and local field potential recordings in anesthetized rats	PCP increases overall neuronal firing and decreases low frequency oscillations	Santana et al. (2011)
	Effects of acute and chronic NMDA antagonism administration on oscillatory hippocampal activity in freely moving rats	Acute injection of MK-801 or ketamine ↑ γ power in CA1 and DG, shifted θ peak to higher frequencies and ↓ θ power in CA1 Chronic ketamine administration ↓ θ and γ oscillations	Kittelberger et al. (2012)
Serotonergic drugs	Oscillatory activity (EEG) in frontal and occipital cortices	↑ aberrant γ after systemic administration of nonselective NMDAR antagonists and by NR2A-preferring antagonists	Kocsis (2012)
	Mouse EEG during repeated auditory stimuli	Ketamine and MK-801 ↓ high frequency evoked and total power, ↑ baseline high frequency power, ↓ high frequency intertrial coherence	Saunders et al. (2012)
	Oscillatory activity and neuron firing rate in PFC I freely moving rats	MK-801 causes an overall ↑ neuron firing and ↓ correlation between spike rate and γ band.	Wood et al. (2012)
	mPFC pyramidal neuron single unit recordings and local field potential recordings in choral hydrate anesthetized rats	DOI caused an overall ↑ pyramidal neuron firing and ↓ slow cortical oscillations	Celada et al. (2008)
	Oscillatory activity and neuron firing rate in PFC I freely moving rats	DOI causes an overall ↓ neuron firing and ↓ correlation between spike rate and γ band.	Wood et al. (2012)

Dopaminergic drugs	Neocortical spontaneous γ oscillations in freely moving rats	d-Amphetamine and apomorphine \uparrow cortical γ power	Pinault (2008)
Cannabinoid-1 receptor activation	Hippocampus, entorhinal cortex and mPFC recordings in freely moving rats	CP-55940 \downarrow θ power in the hippocampus and \downarrow γ power in the hippocampus and entorhinal cortex	Hajos et al. (2008)
Developmental MAM	mPFC single-unit and local field potential recordings in anesthetized adult rats	Absent slow and fast field potential oscillations, more regular spike firing activity	Goto and Grace (2006)
	mPFC and ventral hippocampus local field potential recordings in a latent inhibition paradigm (adult rats)	No significant alterations in spontaneous activity. MAM attenuates effects on conditioned-stimuli evoked oscillatory activity.	Lodge et al. (2009)
	Visual and motor cortex EEG recordings in behaving adult rats	\downarrow visual cortex γ oscillations and \uparrow motor cortex high frequency oscillations in MAM treated animals in response to NMDAR antagonism	Phillips et al. (2012)
Neonatal ventral hippocampal lesion	Spontaneous frontal and parietal EEG recordings in prepuberal and adult rats	Prepuberal rats: \uparrow δ , θ and α power Adult rats: \uparrow δ and θ power	Ahnaou et al. (2007)
	Spontaneous frontal and parietal EEG recordings in prepuberal and adult rats	Prepuberal rats: \uparrow δ , θ and α power Adult rats: \uparrow δ and θ power	Ahnaou et al. (2007)
	Frontal, parietal and occipital EEG recordings in behaving adult rats	\downarrow parietal and occipital at 1–30 Hz	Valdes-Cruz et al. (2012)
Genetic			
PV-Cre/NR1f/f mice	CA1 local field potential and unitary neuronal recordings in freely behaving mice	\downarrow and altered θ oscillation, \uparrow γ oscillation and less modulated by θ rhythm	Korotkova et al. (2010)
	Somatosensory single unit and local field potential recordings in anesthetized and awake mice	\uparrow baseline cortical γ band and \downarrow sensitivity to NMDAR antagonists-induced effects on γ oscillations	Carlen et al. (2012)
<i>Df(16)A</i> ^{+/-} mice	Single unit and local field potential recordings in behaving mice during working memory task	\downarrow phase locking of PFC neurons to hippocampal θ rhythm and \downarrow coherence between PFC and hippocampal local field potentials	Sigurdsson et al. (2010)
ErbB4 ^{MHC-Erb4 -/-} mice	Rat, WT and KO mice hippocampal slices	Mutation \downarrow kainate-induced γ oscillations and avoids the potentiating effect of NRG1 on these oscillations	Fisahn et al. (2009)
Dys1 ^{-/-} mice	EEG recordings in hippocampus during auditory processing	\downarrow evoked high γ power and deficit suppressing late γ activity	Carlson et al. (2011)
GCLM ^{-/-} mice	Hippocampal slices <i>in vitro</i> recordings	\downarrow kainite induced β and γ oscillations	Steullet et al. (2010)
DAT ^{-/-} mice	Hippocampal and prelimbic PFC local field potential during spontaneous activity and during the exploration of a novel environment	\uparrow γ phase signalling	Dzirasa et al. (2009)
NR1 KD	Hippocampal and prelimbic PFC local field potential during spontaneous activity and during the exploration of a novel environment	\downarrow θ - γ phase coupling	Dzirasa et al. (2009)

CA, Cornu ammonis; DG, dentate gyrus; DOI, 1-(2,5-dimethoxy-4-iodophenyl-2-aminopropane); EEG, electroencephalogram; FC, frontal cortex; KD, knock down; KO, knock out; MAM, methylazoxymethanol acetate; MUA, multi-unit activity; NMDAR, N-methyl-D-aspartate receptor; NRG1, neuregulin 1; PFC, prefrontal cortex; PCP, phencyclidine; WT, wild-type.

information and to allow for coordinated activity between different neuronal networks in the temporal plane: information is encoded by spiking activity, but also by the time at which they are produced.

The generation of brain oscillations involves a balance between excitatory and inhibitory transmission in the network, which depends on the individual properties of the components. Hence, slow oscillations result from the interaction of cortical, thalamo-cortical and reticular nucleus oscillators (Crunelli and Hughes, 2010), whereas δ oscillations depend upon cortical and thalamocortical components (Petsche et al., 1984; Leresche et al., 1990; McCormick and Pape, 1990; Steriade et al., 1993; Llinas and Steriade, 2006). Low frequency oscillations (slow and δ oscillations) are involved in several brain functions *per se*, including short- and long-term memory (Bodizs et al., 2002; Marshall et al., 2006; Basar and Guntekin, 2008). Additionally, they are essential for organizing higher frequency activities in sequences of complex oscillations (Steriade, 2006).

The γ oscillations (30–80 Hz) deserve special attention due to their implication in multiple cognitive processes through the phylogenetic scale (Engel and Singer, 2001): sensory and perceptual processing; short and long-term memory; attention; executive functions, among others. Parvalbumin positive GABAergic interneurons are strongly involved in the generation of γ oscillations. They are fast-spiking interneurons, with special electrical properties, which are able to control large populations of pyramidal neurons via large networks connected by gap junctions (Traub et al., 2000, 2001; Galarreta and Hestrin, 2001). These properties make them excellent candidates to spread fast oscillations through neuronal networks, although other cells and neurotransmitter systems have been also involved (Belforte et al., 2010; Korotkova et al., 2010; Carlen et al., 2012).

Since brain oscillations mirror neuronal and network dynamics, they may provide a valuable tool to study the aetiology and pathophysiology of mental illnesses such as schizophrenia. Moreover, the study of brain oscillations can be a powerful translational tool, enabling comparisons between patients, healthy individuals and animal models. EEG recordings have been used to identify biomarkers, endophenotypes or prognostic indicators in schizophrenia. Indeed, schizophrenia symptoms may result from impaired connectivity, communication and coordination between brain regions (Hoffman and Mcglashan, 1993; Skelly et al., 2008; Camchong et al., 2011). Brain oscillations have also been examined in a variety of animal models of schizophrenia (Table 2).

Recent studies show an increase of resting state γ activity in schizophrenic patients compared to healthy controls (Venables et al., 2009; Kikuchi et al., 2011; Spencer, 2012). This disruption agrees with the reported alterations on GABAergic neurotransmission in schizophrenic patients (Lewis et al., 2005), especially in fast-spiking interneurons, as well as deficits in NMDA glutamatergic neurotransmission (Krystal et al., 2003; Konradi and Heckers, 2003; Woo et al., 2008). Likewise, abnormalities in cortico-subcortical communications (e.g. thalamocortical) may be examined via EEG sleep recordings. Slow wave sleep deficits have been reported in schizophrenic patients, associated with negative symptoms. Specifically, schizophrenia patients show decreased δ wave counts, reductions in δ and θ power and alterations in the laterality of these measures compared with healthy controls (Keshavan et al., 1998; Sekimoto et al., 2007). Alterations in α activity during sleep have also been correlated with positive and negative symptom scores (Poulin et al., 2008). Likewise, enhanced slow wave, δ , θ and β activity and decreased α activity in the resting state has been associated with schizophrenia (Rockstroh et al., 2007; Bates et al., 2009; Begic et al., 2011). Alterations in the δ band frequency have been associated with negative symptoms of the illness (Itoh et al., 2011).

Moreover, EEG patterns allow distinction between patients with schizophrenia and other psychiatric disorders (Rockstroh et al., 2007; Venables et al., 2009; Begic et al., 2011) and between different groups of schizophrenic patients (violent and non-violent schizophrenic patients; Schug et al., 2011) and positive *vs.* negative type schizophrenia (Begic et al., 2000, 2009).

Finally, different strategies have been used to model schizophrenia in healthy subjects. One of them is the administration of psychotomimetic drugs such as NMDA antagonists (Krystal et al., 2003). Using this approach, it has been shown that the administration of subanaesthetic doses of ketamine to healthy subjects augmented high frequency oscillations (40–85 Hz) and reduced low frequency oscillations (1–5 Hz) mimicking some of the oscillatory alterations of schizophrenia (Hong et al., 2010). Similar results have been reported using other hallucinogenic drugs disrupting serotonergic neurotransmission (Oughourl et al., 1971; Riba et al., 2002).

Effects of psychotomimetic agents on low frequency cortical oscillations

The cellular effects of PCP described earlier were accompanied by a simultaneous and marked alteration

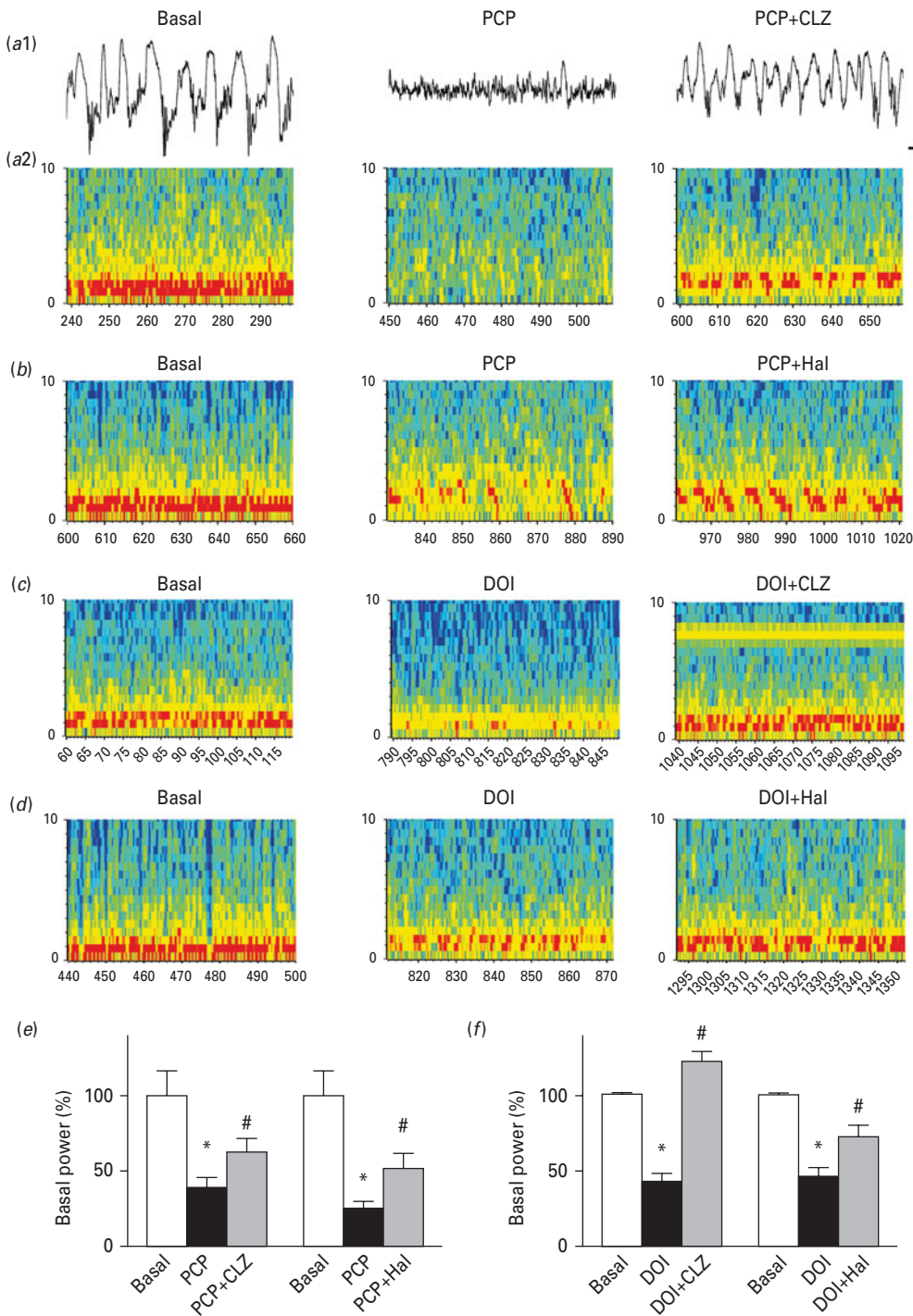

Fig. 5. Reduction of low frequency cortical oscillations (LFCO) by phencyclidine (PCP) and 1-(2,5-dimethoxy-4-iodophenyl)-2-aminopropane; DOI. (a1): local field potential recording in basal conditions (left), after the administration of PCP (0.25 mg/kg i.v.; middle) and after the subsequent administration of clozapine (CLZ, 1 mg/kg i.v.). Note the marked reduction of the magnitude of the LFCO by PCP and the reversal of this action by CLZ. (a-d): spectrograms showing the effect of PCP (a2, b) and DOI (c, d) on LFCO, as well as the reversal of these actions by CLZ and haloperidol (Hal). Note the marked loss of the power of LFCO by PCP and DOI, denoted by a reduction of the colour intensity (red) at low frequencies. Ordinate range is 0–10 Hz; abscissa is a 1-min period during each treatment. (e) and (f): bar diagrams showing average effects of PCP (e) and DOI (f) on the power of LFCO as well as the reversal by CLZ and Hal; $n=20$ for PCP and $n=51$ for DOI. Data taken from Kargieman et al. (2007) and Celada et al. (2008). * $p < 0.05$ vs. basal; # $p < 0.05$ vs. PCP or DOI.

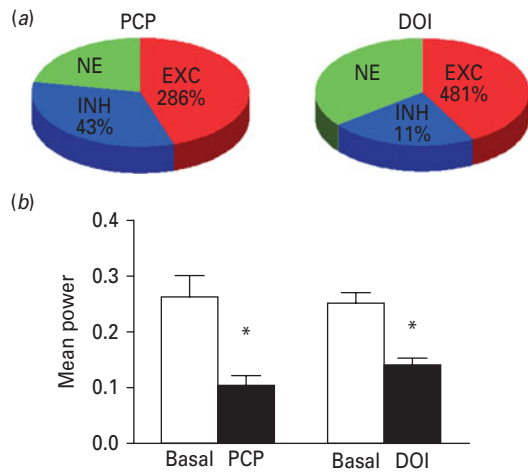

Fig. 6. Comparison of the effects of phencyclidine (PCP, 9.25 mg/kg i.v.) and 1-(2,5-dimethoxy-4-iodophenyl)-2-aminopropane; DOI, 0.05–0.3 mg/kg i.v.) on the discharge rate of pyramidal neurons (a) and on the power of low frequency oscillations (b) in prefrontal cortex. (a) Note the similar proportions of pyramidal neurons excited (EXC), inhibited (INH) or unaffected (NE) by both treatments, as shown by the sector angle. Figures inside each sector are the average change *vs.* baseline in the discharge rate. (b) At the doses used, the effect of PCP on the power of low frequency oscillations was slightly more marked than that of DOI. * $p < 0.05$ *vs.* basal. Data from Puig et al. (2003), Kargieman et al. (2007) and Celada et al. (2008).

of low frequency cortical oscillations (LFCO; 0.3–4 Hz) in mPFC and of δ waves in the thalamus (Kargieman et al., 2007; Santana et al., 2011). PCP administration dramatically reduced the power of LFCO, recorded in parallel with neuronal discharge, irrespective of whether the recorded pyramidal neuron was excited, inhibited or unaffected by PCP. Figure 5 shows the effect of PCP on LFCO in the mPFC of the anaesthetized rat. Interestingly, PCP also produced very marked desynchronization of the neuronal discharge from the active (or 'up') phases of LFCO. Spikes are typically fired during the active phases of LFCO, corresponding to 'up' or depolarized states recorded intracellularly. The percentage of spikes fired in active phases of the LFCO was $90 \pm 3\%$ in baseline conditions. PCP reduced this value to $59 \pm 11\%$ (note that maximal reduction is to 50%; i.e. a random distribution between active and inactive phases; Kargieman et al., 2007).

In addition to NMDA receptor antagonists, serotonergic hallucinogens are considered pharmacological models of schizophrenia due to their ability to evoke some psychotic symptoms, such as hallucinations and perceptual disturbances. In addition, these agents activate 5-HT_{2A} receptors (Nichols, 2004) whereas

atypical antipsychotic drugs are antagonists of the same receptors (Meltzer, 1999). 1-(2,5-Dimethoxy-4-iodophenyl)-2-aminopropane; DOI) is a partial 5-HT_{2A/2C} agonist that evokes long-lasting alterations in consciousness and perception (Nichols, 2004), an effect mediated by activation of 5-HT_{2A} receptors (Schreiber et al., 1994; Martin-Ruiz et al., 2001).

The systemic administration of DOI (50–300 μ g/kg i.v.) produced a marked alteration of the discharge of pyramidal neurons in mPFC, which was similar to that produced by PCP (Fig. 6). Hence, DOI administration increased the discharge rate of 39% of the recorded neurons (to 481% of baseline), reduced that of 27% (to 11% of baseline) and left unaffected 34% of the recorded pyramidal neurons, producing an overall increase of 240% of the pyramidal discharge in mPFC (Puig et al., 2003). In all instances, DOI produced a marked and concurrent reduction of LFCO to 56% of baseline, an effect slightly less marked than that evoked by PCP (Fig. 4). All these effects were antagonized by the subsequent administration of the selective 5-HT_{2A} receptor antagonist M100907, indicating the exclusive participation of 5-HT_{2A} receptors. The inhibitory effect of DOI appears to depend on the activation of 5-HT_{2A} receptors in GABAergic interneurons, as it was reversed by the subsequent administration of the GABA_A receptor antagonist picrotoxinin (Puig et al., 2003). Interestingly, this inhibitory effect appears to increase with dose, as recently reported (Wood et al., 2012).

Reversal by antipsychotic drugs: mechanisms involved

Behavioural alterations induced by non-competitive NMDA receptor antagonists and 5-HT_{2A} agonists are reversed by antipsychotic drugs, in particular by second generation or atypical antipsychotic drugs (Geyer et al., 2001). Given the similar disruption of PFC activity produced by the two different models of schizophrenia used (NMDA receptor antagonist and 5-HT_{2A} receptor agonist) we examined whether PCP- and DOI-induced alterations could be antagonized by classical (haloperidol) and atypical (CLZ) antipsychotic drugs. As shown in Fig. 1, the administration of CLZ completely reversed the increase in firing rate produced by PCP in PFC pyramidal neurons and in thalamic neurons (Kargieman et al., 2007; Santana et al., 2011). Likewise, CLZ pre-treatment prevented the increase in *c-fos* expression in all brain areas examined, including the PFC and thalamic nuclei (Fig. 1).

CLZ also reversed the fall in low frequency oscillation produced by PCP in PFC and thalamic nuclei

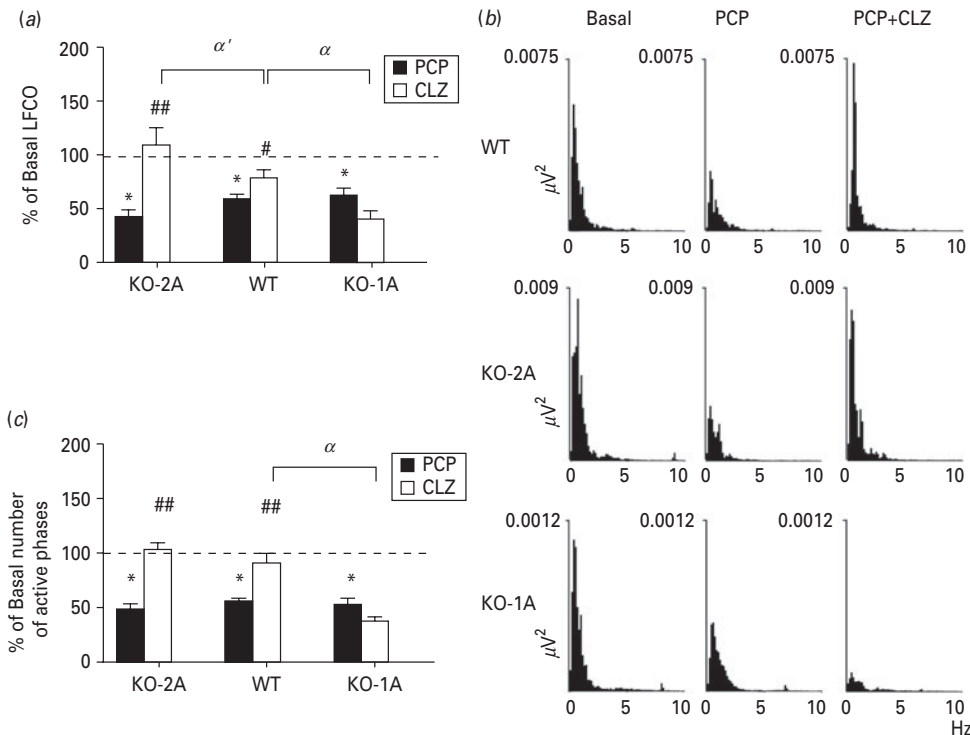

Fig. 7. Effect of phencyclidine (PCP) on low-frequency cortical oscillations (LFCO) in the prefrontal cortex (PFC) of serotonin (5-HT)_{2A} receptor- and 5-HT_{1A}-receptor-knockout (KO) mice (KO-2A and KO-1A, respectively). Graphs showing the average effects of PCP and PCP + clozapine (CLZ) as assessed by the area under the curves of power spectra of LFCO (a) and on the number of active phases per min (c) ($n=23$, 11 and 12 for wild type (WT), KO-1A and KO-2A mice. * $p<0.001$ vs. basal; # $p<0.05$ vs. PCP; ## $p<0.0005$ vs. PCP; α $p<0.0002$, α' $p<0.01$ post hoc test after two-way analysis of variance. (b) Representative examples of the power spectra of LFCO in mice PFC obtained in basal conditions, after PCP and after subsequent CLZ administration (10 and 20 min after PCP administration, respectively) in the three genotypes. Reproduced with permission from Kargieman et al. (2012).

(Kargieman et al., 2007; Santana et al., 2011). It also reversed the alteration induced by the serotonergic hallucinogen DOI in PFC (Celada et al., 2008). Figure 5 shows representative examples of the reversal by CLZ of the alterations in LFCO induced by PCP and DOI as well as the average data from all recordings. When examined, the administration of haloperidol also reversed PCP and DOI effects. Hence, haloperidol was equally able to reverse the effect of PCP and DOI on LFCO (Fig. 5) as well as the effect of PCP on pyramidal neuron discharge in PFC.

The mechanisms involved in the reversal of PCP and DOI actions are not fully elucidated. At cellular level, the reversal by CLZ of PCP effects may depend on an increased GABA input onto pyramidal neurons, given the opposite effects of PCP +CLZ on *c-fos* expression in GABAergic neurons (increase vs. PCP alone) and pyramidal neurons (decrease vs. PCP alone; Kargieman et al., 2007). However, this possibility requires further experimental testing.

The reversal by CLZ of PCP effects appears to require the activation of 5-HT_{1A} receptors. Hence, PCP was equally effective in reducing LFCO in the PFC of wild-type (WT) mice and of mice lacking 5-HT_{1A} or 5-HT_{2A} receptors [1A-knock out (KO) and 2A-KO, respectively; Kargieman et al., 2012]. However, the subsequent administration of CLZ reversed the effects of PCP in WT mice and in 2A-KO, but failed to do so in 1A-KO (Kargieman et al., 2012), indicating the requirement of 5-HT_{1A} receptors (Fig. 7). On-going pharmacological studies also support the involvement of 5-HT_{1A} receptors in the reversal of PCP effects on LFCO. Hence, the selective 5-HT_{1A} agonist BAY×3702 completely reversed the fall in LFCO power produced by PCP in rat PFC and the subsequent administration of CLZ did not produce any additional effect (L. Lladó-Pelfort, P. Celada, E. Troyano-Rodriguez and F. Artigas, unpublished observations). These results cannot be explained by the *in vitro* affinity of CLZ for 5-HT_{1A} receptors. However, atypical antipsychotic

drugs, including CLZ, behave as agonists at 5-HT_{1A} receptors *in vivo* to increase PFC DA release (Rollema et al., 1997; Ichikawa et al., 2001; Diaz-Mataix et al., 2005; Bortolozzi et al., 2010).

5-HT_{1A} and 5-HT_{2A} receptors are highly co-expressed in PFC neurons (Amargos-Bosch et al., 2004). Thus, 5-HT_{2A} receptor blockade by CLZ might alter the physiological balance between both receptors, resulting in an increase of 5-HT_{1A} receptor-mediated neurotransmission. However, these results, together with additional data using also 5-HT receptor KO mice (Bortolozzi et al., 2010) do not support this view, since CLZ reversed the effects of PCP on LFCO in KO-2A mice whereas it did not in KO-1A mice. Thus, the effect of CLZ may depend on some still unknown pharmacological property, perhaps resulting from its *in vivo* occupancy of 5-HT_{1A} receptor (Chou et al., 2003). Alternatively, the reversal by CLZ of the effects of DOI may depend on the direct competition of both drugs at PFC 5-HT_{2A} receptors.

Given the almost exclusive high affinity of haloperidol for DA D₂ receptors, the reversal of PCP and DOI effects by haloperidol is likely dependent on the *in vivo* blockade of such receptors which participate in the excitatory–inhibitory balance in PFC (Tseng et al., 2006).

Given the role of PFC in cognitive functions, the normalization of its function by antipsychotic drugs might be viewed as an electrophysiological signature of potential pro-cognitive actions. However, the pro-cognitive action of antipsychotic drugs is far from being established and actually, many drugs show deleterious effects on cognition likely due to the blockade of DA actions in PFC. In addition to cognitive processes, the PFC participates in affective control and higher brain functions such as sensory integration, attention, decision-making, behavioural inhibition, language etc., whose alterations contribute to psychotic symptoms. Therefore, it is very likely that the antipsychotic reversal of PCP and DOI actions in PFC are related to the antipsychotic effect rather than to potential pro-cognitive actions of first and second generation antipsychotic drugs.

Concluding remarks

Data obtained in recent years has revealed that psychotomimetic agents markedly disrupt neuronal activity in the PFC and anatomically-connected thalamic areas, such as the centromedial and dorsomedial nuclei. In parallel, these agents alter the power of low frequency oscillations in PFC and in the thalamus, when examined. Given the crucial role of these brain

networks in adapting behavioural responses to external sensory inputs, among others, it is likely that the observed abnormalities underlie, at least in part, the psychotomimetic action of these agents. The link with schizophrenia symptoms is strengthened by the observation that antipsychotic agents reverse the disruption of thalamic and cortical activity evoked by PCP and DOI. Overall, the alterations of thalamo-cortical activity induced by psychotomimetic agents can be successfully used to gain further insight into the neurobiological basis of schizophrenia symptoms and to examine the potential antipsychotic activity of new drugs in development.

Acknowledgements

Supported by the Innovative Medicines Initiative Joint Undertaking (IMI) under Grant Agreement No. 115008 (NEWMEDS). IMI is a public–private partnership between the European Union and the European Federation of Pharmaceutical Industries and Associations. Support from the following grants is also acknowledged: SAF 2012-35183 (Ministry of Economy and Competitiveness and European Regional Development Fund), PI09/1245 and PI12/00156 (PN de I+D+I 2008-2011, ISCIII-Subdirección General de Evaluación y Fomento de la Investigación cofinanced by the European Regional Development Fund. ‘Una manera de hacer Europa’) and Centro de Investigación Biomédica en Red de Salud Mental, CIBERSAM (P82, 11INT3). Support from the Generalitat de Catalunya (SGR20093) is also acknowledged. P.C. is supported by the Researcher Stabilization Program of the Health Department of the Generalitat de Catalunya. M.R. is recipient of an IDIBAPS fellowship.

Statement of Interest

None.

References

- Ahnaou A, Nayak S, Heylen A, Ashton D, Drinkenburg WHIM (2007) Sleep and EEG profile in neonatal hippocampal lesion model of schizophrenia. *Physiol Behav* 92:461–467.
- Alelu-Paz R, Gimenez-Amaya JM (2008) The mediodorsal thalamic nucleus and schizophrenia. *J Psychiatry Neurosci* 33:489–498.
- Amargos-Bosch M, Bortolozzi A, Puig MV, Serrats J, Adell A, Celada P, Toth M, Mengod G, Artigas F (2004) Co-expression and *in vivo* interaction of serotonin(1A) and

- serotonin(2A) receptors in pyramidal neurons of prefrontal cortex. *Cereb Cortex* 14:281–299.
- Amargos-Bosch M, Lopez-Gil X, Artigas F, Adell A (2006) Clozapine and olanzapine, but not haloperidol, suppress serotonin efflux in the medial prefrontal cortex elicited by phencyclidine and ketamine. *Int J Neuropsychopharm* 9:565–573.
- Anver H, Ward PD, Magony A, Vreugdenhil M (2011) NMDA Receptor hypofunction phase couples independent gamma-oscillations in the rat visual cortex. *Neuropsychopharmacology* 36:519–528.
- Artigas F (2010) The prefrontal cortex: a target for antipsychotic drugs. *Acta Psychiatr Scand* 121:11–21.
- Aston-Jones G, Cohen JD (2005) An integrative theory of locus coeruleus-norepinephrine function: adaptive gain and optimal performance. *Annu Rev Neurosci* 28:403–450.
- Basar E, Guntekin B (2008) A review of brain oscillations in cognitive disorders and the role of neurotransmitters. *Brain Res* 1235:172–193.
- Bates AT, Kiehl KA, Laurens KR, Liddle PF (2009) Low-frequency EEG oscillations associated with information processing in schizophrenia. *Schizophr Res* 115:222–230.
- Begic D, Hotujac L, Jokic-Begic N (2000) Quantitative EEG in 'positive' and 'negative' schizophrenia. *Acta Psychiatr Scand* 101:307–311.
- Begic D, Mahnik-Milos M, Grubisin J (2009) Eeg characteristics in depression, 'negative' and 'positive' schizophrenia. *Psychiatr Danubina* 21:579–584.
- Begic D, Popovic-Knapic V, Grubisin J, Kosanovic-Rajacic B, Filipic I, Telarovic I, Jakovljevic M (2011) Quantitative electroencephalography in schizophrenia and depression. *Psychiatr Danubina* 23:355–362.
- Belforte JE, Zsiros V, Sklar ER, Jiang ZH, Yu G, Li YQ, Quinlan EM, Nakazawa K (2010) Postnatal NMDA receptor ablation in corticolimbic interneurons confers schizophrenia-like phenotypes. *Nat Neurosci* 13:76–U240.
- Berendse HW, Groenewegen HJ (1991) Restricted cortical termination fields of the midline and intralaminar thalamic nuclei in the rat. *Neuroscience* 42:73–102.
- Berger H (1929) Electroencephalogram in humans. *Archiv fur Psychiatrie und Nervenkrankheiten* 87:527–570.
- Bodizs R, Bekesy M, Szucs A, Barsi P, Halasz P (2002) Sleep-dependent hippocampal slow activity correlates with waking memory performance in humans. *Neurobiol Learn Mem* 78:441–457.
- Bortolozzi A, Masana M, Diaz-Mataix L, Cortes R, Scorza MC, Gingrich JA, Toth M, Artigas F (2010) Dopamine release induced by atypical antipsychotics in prefrontal cortex requires 5-HT(1A) receptors but not 5-HT(2A) receptors. *Int J Neuropsychopharmacol* 13:1299–1314.
- Breier A, Malhotra AK, Pinals DA, Weisenfeld NI, Pickar D (1997) Association of ketamine-induced psychosis with focal activation of the prefrontal cortex in healthy volunteers. *Am J Psychiatry* 154:805–811.
- Camchong J, MacDonald AW, Bell C, Mueller BA, Lim KO (2011) Altered functional and anatomical connectivity in schizophrenia. *Schizophr Bull* 37:640–650.
- Cardinal RN, Parkinson JA, Hall J, Everitt BJ (2002) Emotion and motivation: the role of the amygdala, ventral striatum, and prefrontal cortex. *Neurosci Biobehav Rev* 26:321–352.
- Carlen M, Meletis K, Siegle JH, Cardin JA, Futai K, Vierling-Claassen D, Ruhlmann C, Jones SR, Deisseroth K, Sheng M, Moore CI, Tsai LH (2012) A critical role for NMDA receptors in parvalbumin interneurons for gamma rhythm induction and behavior. *Mol Psychiatry* 17:537–548.
- Carlson GC, Talbot K, Halene TB, Gandal MJ, Kazi HA, Schlosser L, Phung QH, Gur RE, Arnold SE, Siegel SJ (2011) Dysbindin-1 mutant mice implicate reduced fast-phasic inhibition as a final common disease mechanism in schizophrenia. *Proc Natl Acad Sci USA* 108:E962–E970.
- Carlsson M, Carlsson A (1989) Dramatic synergism between MK-801 and clonidine with respect to locomotor stimulatory effect in monoamine-depleted mice. *J Neural Transm* 77:65–71.
- Cavara NA, Hollmann M (2008) Shuffling the deck anew: how NR3 tweaks NMDA receptor function. *Mol Neurobiol* 38:16–26.
- Celada P, Artigas F (2007) Serotonin modulation of cortical activity. In: *Monoaminergic modulation of cortical excitability* (Tseng KY, Atzori M, ed), pp67–89. New York: Springer Science+Business Media, LLC.
- Celada P, Puig MV, Diaz-Mataix L, Artigas F (2008) The hallucinogen DOI reduces low-frequency oscillations in rat prefrontal cortex: reversal by antipsychotic drugs. *Biol Psychiatry* 64:392–400.
- Chou YH, Hallidin C, Farde L (2003) Occupancy of 5-HT1A receptors by clozapine in the primate brain: a PET study. *Psychopharmacology* 166:234–240.
- Clinton SM, Meador-Woodruff JH (2004) Thalamic dysfunction in schizophrenia: neurochemical, neuropathological, and *in vivo* imaging abnormalities. *Schizophr Res* 69:237–253.
- Crunelli V, Hughes SW (2010) The slow (<1 Hz) rhythm of non-REM sleep: a dialogue between three cardinal oscillators. *Nat Neurosci* 13:10–18.
- Davidson RJ, Irwin W (1999) The functional neuroanatomy of emotion and affective style. *Trends Cogn Sci* 3:11–21.
- de Almeida J, Mengod G (2007) Quantitative analysis of glutamatergic and GABAergic neurons expressing 5-HT2A receptors in human and monkey prefrontal cortex. *J Neurochem* 103:475–486.
- de Almeida J, Mengod G (2008) Serotonin 1A receptors in human and monkey prefrontal cortex are mainly expressed in pyramidal neurons and in a GABAergic interneuron subpopulation: implications for schizophrenia and its treatment. *J Neurochem* 107:488–496.
- Defelipe J, Hendry SHC, Jones EG (1989) Visualization of chandelier cell axons by parvalbumin immunoreactivity in monkey cerebral-cortex. *Proc Natl Acad Sci USA* 86:2093–2097.
- Defelipe J et al. (2013) New insights into the classification and nomenclature of cortical GABAergic interneurons. *Nat Rev Neurosci* 14:202–216.

- Devinsky O, Morrell MJ, Vogt BA (1995) Contributions of anterior cingulate cortex to behaviour. *Brain* 118(Pt 1):279–306.
- Diaz-Mataix L, Scorza MC, Bortolozzi A, Toth M, Celada P, Artigas F (2005) Involvement of 5-HT_{1A} receptors in prefrontal cortex in the modulation of dopaminergic activity: role in atypical antipsychotic action. *J Neurosci* 25:10831–10843.
- Dzirasa K, Ramsey AJ, Takahashi DY, Stapleton J, Potes JM, Williams JK, Gainetdinov RR, Sameshima K, Caron MG, Nicolelis MAL (2009) Hyperdopaminergia and NMDA receptor hypofunction disrupt neural phase signaling. *J Neurosci* 29:8215–8224.
- Engel AK, Singer W (2001) Temporal binding and the neural correlates of sensory awareness. *Trends Cogn Sci* 5:16–25.
- Fisahn A, Neddens J, Yan LQ, Buonanno A (2009) Neuregulin-1 modulates hippocampal gamma oscillations: implications for schizophrenia. *Cereb Cortex* 19:612–618.
- Fuster JM (2001) The prefrontal cortex – an update: time is of the essence. *Neuron* 30:319–333.
- Fuster JM (2008) The prefrontal cortex, 4th edn. Los Angeles, California, USA: Academic Press.
- Gabbott PL, Warner TA, Jays PR, Salway P, Busby SJ (2005) Prefrontal cortex in the rat: projections to subcortical autonomic, motor, and limbic centers. *J Comp Neurol* 492:145–177.
- Galarreta M, Hestrin S (2001) Electrical synapses between GABA-releasing interneurons. *Nat Rev Neurosci* 2:425–433.
- Geyer MA, Krebs-Thomson K, Braff DL, Swerdlow NR (2001) Pharmacological studies of prepulse inhibition models of sensorimotor gating deficits in schizophrenia: a decade in review. *Psychopharmacology* 156:117–154.
- Goto Y, Grace AA (2006) Alterations in medial prefrontal cortical activity and plasticity in rats with disruption of cortical development. *Biol Psychiatry* 60:1259–1267.
- Groenewegen HJ, Uylings HB (2000) The prefrontal cortex and the integration of sensory, limbic and autonomic information. *Prog Brain Res* 126:3–28.
- Hajos M, Hoffmann WE, Kocsis B (2008) Activation of cannabinoid-1 receptors disrupts sensory gating and neuronal oscillation: relevance to schizophrenia. *Biol Psychiatry* 63:1075–1083.
- Harrison PJ (1999) The neuropathological effects of antipsychotic drugs. *Schizophr Res* 40:87–99.
- Harrison PJ, Weinberger DR (2005) Schizophrenia genes, gene expression, and neuropathology: on the matter of their convergence. *Mol Psychiatry* 10:40–68.
- Hill XL, Scorza MC (2012) Role of the anterior thalamic nucleus in the motor hyperactivity induced by systemic MK-801 administration in rats. *Neuropharmacology* 62:2440–2446.
- Hoffman RE, Mcglashan TH (1993) Neurodynamics and schizophrenia research – editors introduction. *Schizophr Bull* 19:15–19.
- Homayoun H, Moghaddam B (2007) NMDA receptor hypofunction produces opposite effects on prefrontal cortex interneurons and pyramidal neurons. *J Neurosci* 27:11496–11500.
- Hong LE, Summerfelt A, Buchanan RW, O'Donnell P, Thaker GK, Weiler MA, Lahti AC (2010) Gamma and delta neural oscillations and association with clinical symptoms under subanesthetic ketamine. *Neuropsychopharmacology* 35:632–640.
- Hull C, Isaacson JS, Scanziani M (2009) Postsynaptic mechanisms govern the differential excitation of cortical neurons by thalamic inputs. *J Neurosci* 29:9127–9136.
- Hunt MJ, Falinska M, Leski S, Wojcik DK, Kasicki S (2011) Differential effects produced by ketamine on oscillatory activity recorded in the rat hippocampus, dorsal striatum and nucleus accumbens. *J Psychopharmacol* 25:808–821.
- Ichikawa J, Ishii H, Bonaccorso S, Fowler WL, O'Laughlin IA, Meltzer HY (2001) 5-HT_{2A} and D-2 receptor blockade increases cortical DA release via 5-HT_{1A} receptor activation: a possible mechanism of atypical antipsychotic-induced cortical dopamine release. *J Neurochem* 76:1521–1531.
- Itoh T, Sumiyoshi T, Higuchi Y, Suzuki M, Kawasaki Y (2011) LORETA analysis of three-dimensional distribution of delta band activity in schizophrenia: relation to negative symptoms. *Neurosci Res* 70:442–448.
- Jackson ME, Homayoun H, Moghaddam B (2004) NMDA receptor hypofunction produces concomitant firing rate potentiation and burst activity reduction in the prefrontal cortex. *Proc Natl Acad Sci USA* 101:8467–8472.
- Javitt DC, Zukin SR (1991) Recent advances in the phencyclidine model of schizophrenia. *Am J Psychiatry* 148:1301–1308.
- Jodo E, Suzuki Y, Katayama T, Hoshino KY, Takeuchi S, Niwa SI, Kayama Y (2005) Activation of medial prefrontal cortex by phencyclidine is mediated via a hippocampo-prefrontal pathway. *Cereb Cortex* 15:663–669.
- Jones EG (1997) Cortical development and thalamic pathology in schizophrenia. *Schizophr Bull* 23:483–501.
- Jones EG (2002) Thalamic circuitry and thalamocortical synchrony. *Philos Trans R Soc Lond B Biol Sci* 357:1659–1673.
- Karavanova I, Vasudevan K, Cheng J, Buonanno A (2007) Novel regional and developmental NMDA receptor expression patterns uncovered in NR2C subunit-beta-galactosidase knock-in mice. *Mol Cell Neurosci* 34:468–480.
- Kargieman L, Santana N, Mengod G, Celada P, Artigas F (2007) Antipsychotic drugs reverse the disruption in prefrontal cortex function produced by NMDA receptor blockade with phencyclidine. *Proc Natl Acad Sci USA* 104:14843–14848.
- Kargieman L, Riga MS, Artigas F, Celada P (2012) Clozapine reverses phencyclidine-induced desynchronization of prefrontal cortex through a 5-HT_{1A} receptor-dependent mechanism. *Neuropsychopharmacology* 37:723–733.
- Keshavan MS, Reynolds CF, Miewald JM, Montrose DM, Sweeney JA, Vasko RC, Kupfer DJ (1998) Delta sleep

- deficits in schizophrenia – evidence from automated analyses of sleep data. *Arch Gen Psychiatry* 55:443–448.
- Kikuchi M, Hashimoto T, Nagasawa T, Hirose T, Minabe Y, Yoshimura M, Strik W, Dierks T, Koenig T (2011) Frontal areas contribute to reduced global coordination of resting-state gamma activities in drug-naïve patients with schizophrenia. *Schizophr Res* 130:187–194.
- Kiss T, Hoffmann WE, Hajos M (2011a) Delta oscillation and short-term plasticity in the rat medial prefrontal cortex: modelling NMDA hypofunction of schizophrenia. *Int J Neuropsychopharm* 14:29–42.
- Kiss T, Hoffmann WE, Scott L, Kawabe TT, Milici AJ, Nilsen EA, Hajos M (2011b) Role of thalamic projection in NMDA receptor-induced disruption of cortical slow oscillation and short-term plasticity. *Front Psychiatry* 2:14.
- Kittelberger K, Hur EE, Sazegar S, Keshavan V, Kocsis B (2012) Comparison of the effects of acute and chronic administration of ketamine on hippocampal oscillations: relevance for the NMDA receptor hypofunction model of schizophrenia. *Brain Struct Funct* 217:395–409.
- Kocsis B (2012) Differential role of NR2A and NR2B subunits in *N*-methyl-D-aspartate receptor antagonist-induced aberrant cortical gamma oscillations. *Biol Psychiatry* 71:987–995.
- Konradi C, Heckers S (2003) Molecular aspects of glutamate dysregulation: implications for schizophrenia and its treatment. *Pharmacol Ther* 97:153–179.
- Korotkova T, Fuchs EC, Ponomarenko A, von Engelhardt J, Monyer H (2010) NMDA receptor ablation on parvalbumin-positive interneurons impairs hippocampal synchrony, spatial representations, and working memory. *Neuron* 68:557–569.
- Krystal JH, D'Souza DC, Mathalon D, Perry E, Belger A, Hoffman R (2003) NMDA receptor antagonist effects, cortical glutamatergic function, and schizophrenia: toward a paradigm shift in medication development. *Psychopharmacology (Berl)* 169:215–233.
- Kuroda M, Yokofujita J, Murakami K (1998) An ultrastructural study of the neural circuit between the prefrontal cortex and the mediodorsal nucleus of the thalamus. *Prog Neurobiol* 54:417–458.
- Lau CG, Zukin RS (2007) NMDA receptor trafficking in synaptic plasticity and neuropsychiatric disorders. *Nat Rev Neurosci* 8:413–426.
- Lazarewicz MT, Ehrlichman RS, Maxwell CR, Gandal MJ, Finkel LH, Siegel SJ (2010) Ketamine modulates theta and gamma oscillations. *J Cogn Neurosci* 22:1452–1464.
- Leresche N, Jassikgerschenfeld D, Haby M, Soltesz I, Crunelli V (1990) Pacemaker-like and other types of spontaneous membrane-potential oscillations of thalamocortical cells. *Neurosci Lett* 113:72–77.
- Lewis DA, Gonzalez-Burgos G (2006) Pathophysiologically based treatment interventions in schizophrenia. *Nat Med* 12:1016–1022.
- Lewis DA, Lieberman JA (2000) Catching up on schizophrenia: natural history and neurobiology. *Neuron* 28:325–334.
- Lewis DA, Hashimoto T, Volk DW (2005) Cortical inhibitory neurons and schizophrenia. *Nat Rev Neurosci* 6:312–324.
- Lewis DA, Curley AA, Glausier JR, Volk DW (2012) Cortical parvalbumin interneurons and cognitive dysfunction in schizophrenia. *Trends Neurosci* 35:57–67.
- Lisman JE, Pi HJ, Zhang YC, Otmakhova NA (2010) A thalamo-hippocampal-ventral tegmental area loop may produce the positive feedback that underlies the psychotic break in schizophrenia. *Biol Psychiatry* 68:17–24.
- Llinas RR, Steriade M (2006) Bursting of thalamic neurons and states of vigilance. *J Neurophysiol* 95:3297–3308.
- Lodge DJ, Behrens MM, Grace AA (2009) A loss of parvalbumin-containing interneurons is associated with diminished oscillatory activity in an animal model of schizophrenia. *J Neurosci* 29:2344–2354.
- Lopez-Gil X, Babot Z, Amargos-Bosch M, Sunol C, Artigas F, Adell A (2007) Clozapine and haloperidol differently suppress the MK-801-increased glutamatergic and serotonergic transmission in the medial prefrontal cortex of the rat. *Neuropsychopharmacology* 32:2087–2097.
- Ma JY, Leung LS (2007) The supramammillo-septal-hippocampal pathway mediates sensorimotor gating impairment and hyperlocomotion induced by MK-801 and ketamine in rats. *Psychopharmacology* 191:961–974.
- Marshall L, Helgadottir H, Molle M, Born J (2006) Boosting slow oscillations during sleep potentiates memory. *Nature* 444:610–613.
- Martin-Ruiz R, Puig MV, Celada P, Shapiro DA, Roth BL, Mengod G, Artigas F (2001) Control of serotonergic function in medial prefrontal cortex by serotonin-2A receptors through a glutamate-dependent mechanism. *J Neurosci* 21:9856–9866.
- Mccormick DA, Pape HC (1990) Properties of a hyperpolarization-activated cation current and its role in rhythmic oscillation in thalamic relay neurons. *J Physiol-London* 431:291–318.
- Meltzer HY (1999) The role of serotonin in antipsychotic drug action. *Neuropsychopharmacology* 21:1065–1155.
- Miller EK, Cohen JD (2001) An integrative theory of prefrontal cortex function. *Annu Rev Neurosci* 24:167–202.
- Monyer H, Burnashev N, Laurie DJ, Sakmann B, Seeburg PH (1994) Developmental and regional expression in the rat brain and functional properties of four NMDA receptors. *Neuron* 12:529–540.
- Nichols DE (2004) Hallucinogens. *Pharmacol Ther* 101:131–181.
- Niswender CM, Conn PJ (2010) Metabotropic glutamate receptors: physiology, pharmacology, and disease. *Annu Rev Pharmacol Toxicol* 50:295–322.
- Nunez PL, Srinivasan R (2006) A theoretical basis for standing and traveling brain waves measured with human EEG with implications for an integrated consciousness. *Clin Neurophysiol* 117:2424–2435.
- Oughourl JM, Rougeul A, Verdeaux J (1971) Action of hallucinogens on electroencephalogram. *Therapie* 26:953.

- Paoletti P, Neyton J (2007) NMDA receptor subunits: function and pharmacology. *Curr Opin Pharmacol* 7:39–47.
- Petsche H, Pockberger H, Rappelsberger P (1984) On the search for the sources of the electroencephalogram. *Neuroscience* 11:1–27.
- Phillips KG, Cotel MC, McCarthy AP, Edgar DM, Tricklebank M, O'Neill MJ, Jones MW, Wafford KA (2012) Differential effects of NMDA antagonists on high frequency and gamma EEG oscillations in a neurodevelopmental model of schizophrenia. *Neuropharmacology* 62:1359–1370.
- Phillips ML, Drevets WC, Rauch SL, Lane R (2003) Neurobiology of emotion perception I: the neural basis of normal emotion perception. *Biol Psychiatry* 54:504–514.
- Pinault D (2008) N-methyl d-aspartate receptor antagonists ketamine and MK-801 induce wake-related aberrant, gamma oscillations in the rat neocortex. *Biol Psychiatry* 63:730–735.
- Poulin J, Stip E, Godbout R (2008) REM sleep EEG spectral analysis in patients with first-episode schizophrenia. *J Psychiatr Res* 42:1086–1093.
- Puig MV, Celada P, Diaz-Mataix L, Artigas F (2003) *In vivo* modulation of the activity of pyramidal neurons in the rat medial prefrontal cortex by 5-HT_{2A} receptors: relationship to thalamocortical afferents. *Cereb Cortex* 13:870–882.
- Puig MV, Artigas F, Celada P (2005) Modulation of the activity of pyramidal neurons in rat prefrontal cortex by raphe stimulation *in vivo*: involvement of serotonin and GABA. *Cereb Cortex* 15:1–14.
- Riba J, Anderer P, Morte A, Urbano G, Jane F, Saletu B, Barbanoj MJ (2002) Topographic pharmac-EEG mapping of the effects of the South American psychoactive beverage ayahuasca in healthy volunteers. *Br J Clin Pharmacol* 53:613–628.
- Rockstroh BS, Wienbruch C, Ray WJ, Elbert T (2007) Abnormal oscillatory brain dynamics in schizophrenia: a sign of deviant communication in neural network? *BMC Psychiatry* 7:44.
- Rollema H, Lu Y, Schmidt AW, Zorn SH (1997) Clozapine increases dopamine release in prefrontal cortex by 5-H(1)A receptor activation. *Eur J Pharmacol* 338:R3–R5.
- Santana N, Bortolozzi A, Serrats J, Mengod G, Artigas F (2004) Expression of serotonin_{1A} and serotonin_{2A} receptors in pyramidal and GABAergic neurons of the rat prefrontal cortex. *Cereb Cortex* 14:1100–1109.
- Santana N, Mengod G, Artigas F (2009) Quantitative analysis of the expression of dopamine D-1 and D-2 receptors in pyramidal and GABAergic neurons of the rat prefrontal cortex. *Cereb Cortex* 19:849–860.
- Santana N, Troyano-Rodriguez E, Mengod G, Celada P, Artigas F (2011) Activation of thalamocortical networks by the N-methyl-D-aspartate receptor antagonist phencyclidine: reversal by clozapine. *Biol Psychiatry* 69:918–927.
- Santana N, Mengod G, Artigas F (2012) Expression of alpha₁-adrenergic receptors in rat prefrontal cortex: cellular co-localization with 5-HT_{2A} receptors. *Int J Neuropsychopharmacol* 16:1–13.
- Saunders JA, Ganda MJ, Siegel SJ (2012) NMDA antagonists recreate signal-to-noise ratio and timing perturbations present in schizophrenia. *Neurobiol Dis* 46:93–100.
- Schreiber R, Brocco M, Millan MJ (1994) Blockade of the discriminative stimulus effects of DOI by MDL 100,907 and the 'atypical' antipsychotics, clozapine and risperidone. *Eur J Pharmacol* 264:99–102.
- Schug RA, Yang YL, Raine A, Han CB, Liu JH, Li LJ (2011) Resting EEG deficits in accused murderers with schizophrenia. *Psychiatry Res-Neuroimaging* 194:85–94.
- Seamans JK, Yang CR (2004) The principal features and mechanisms of dopamine modulation in the prefrontal cortex. *Prog Neurobiol* 74:1–58.
- Sebban C, Tesolin-Decros B, Ciprian-Ollivier J, Perret L, Spedding M (2002) Effects of phencyclidine (PCP) and MK 801 on the EEGq in the prefrontal cortex of conscious rats; antagonism by clozapine, and antagonists of AMPA-, alpha(1)- and 5-HT(2A)-receptors. *Br J Pharmacol* 135:65–78.
- Sekimoto M, Kato M, Watanabe T, Kajimura N, Takahashi K (2007) Reduced frontal asymmetry of delta waves during all-night sleep in schizophrenia. *Schizophr Bull* 33:1307–1311.
- Selemon LD, Goldman-Rakic PS (1999) The reduced neuropil hypothesis: a circuit based model of schizophrenia. *Biol Psychiatry* 45:17–25.
- Shergill SS, Brammer MJ, Williams SC, Murray RM, McGuire PK (2000) Mapping auditory hallucinations in schizophrenia using functional magnetic resonance imaging. *Arch Gen Psychiatry* 57:1033–1038.
- Shipp S (2007) Structure and function of the cerebral cortex. *Curr Biol* 17:R443–R449.
- Sigurdsson T, Stark KL, Karayiorgou M, Gogos JA, Gordon JA (2010) Impaired hippocampal-prefrontal synchrony in a genetic mouse model of schizophrenia. *Nature* 464:763–767.
- Skelly LR, Calhoun V, Meda SA, Kim J, Mathalon DH, Pearlson GD (2008) Diffusion tensor imaging in schizophrenia: relationship to symptoms. *Schizophr Res* 98:157–162.
- Spencer KM (2012) Baseline gamma power during auditory steady-state stimulation in schizophrenia. *Front Hum Neurosci* 5:190.
- Steinbusch HWM (1981) Distribution of serotonin-immunoreactivity in the central nervous-system of the rat – cell-bodies and terminals. *Neuroscience* 6:557–618.
- Steriade M (2001) The GABAergic reticular nucleus: a preferential target of corticothalamic projections. *Proc Natl Acad Sci USA* 98:3625–3627.
- Steriade M (2006) Grouping of brain rhythms in corticothalamic systems. *Neuroscience* 137:1087–1106.
- Steriade M, Nunez A, Amzica F (1993) Intracellular analysis of relations between the slow (less-than-1 Hz) neocortical oscillation and other sleep rhythms of the electroencephalogram. *J Neurosci* 13:3266–3283.

- Steullet P, Cabungcal JH, Kulak A, Kraftsik R, Chen Y, Dalton TP, Cuenod M, Do KQ (2010) Redox dysregulation affects the ventral but not dorsal hippocampus: impairment of parvalbumin neurons, gamma oscillations, and related behaviors. *J Neurosci* 30:2547–2558.
- Sun QQ, Huguenard JR, Prince DA (2006) Barrel cortex microcircuits: thalamocortical feedforward inhibition in spiny stellate cells is mediated by a small number of fast-spiking interneurons. *J Neurosci* 26:1219–1230.
- Suzuki Y, Jodo E, Takeuchi S, Niwa S, Kayama Y (2002) Acute administration of phencyclidine induces tonic activation of medial prefrontal cortex neurons in freely moving rats. *Neuroscience* 114:769–779.
- Swanson CJ, Bures M, Johnson MP, Linden AM, Monn JA, Schoepp DD (2005) Metabotropic glutamate receptors as novel targets for anxiety and stress disorders. *Nat Rev Drug Discov* 4:131–144.
- Traub RD, Bibbig A, Fisahn A, Lebeau FEN, Whittington MA, Buhl EH (2000) A model of gamma-frequency network oscillations induced in the rat CA3 region by carbachol *in vitro*. *Eur J Neurosci* 12:4093–4106.
- Traub RD, Kopell N, Bibbig A, Buhl EH, Lebeau FEN, Whittington MA (2001) Gap junctions between interneuron dendrites can enhance synchrony of gamma oscillations in distributed networks. *J Neurosci* 21:9478–9486.
- Tseng KY, Mallet N, Toreson KL, Le Moine C, Gonon F, O'Donnell P (2006) Excitatory response of prefrontal cortical fast-spiking interneurons to ventral tegmental area stimulation *in vivo*. *Synapse* 59:412–417.
- Valdes-Cruz A, Negrete-Diaz JV, Magdaleno-Madrigal VM, Martinez-Vargas D, Fernandez-Mas R, Almazan-Alvarado S, Torres-Garcia ME, Flores G (2012) Electroencephalographic activity in neonatal ventral hippocampus lesion in adult rats. *Synapse* 66:738–746.
- Vaneden CG, Hoorneman EMD, Buijs RM, Matthijssen MAH, Geffard M, Uylings HBM (1987) Immunocytochemical localization of dopamine in the prefrontal cortex of the rat at the light and electron-microscopic level. *Neuroscience* 22:849–862.
- Venables NC, Bernat EM, Sponheim SR (2009) Genetic and disorder-specific aspects of resting state EEG abnormalities in schizophrenia. *Schizophr Bull* 35:826–839.
- Vukadinovic Z (2011) Sleep abnormalities in schizophrenia may suggest impaired trans-thalamic cortico-cortical communication: towards a dynamic model of the illness. *Eur J Neurosci* 34:1031–1039.
- Vukadinovic Z, Rosenzweig I (2012) Abnormalities in thalamic neurophysiology in schizophrenia: could psychosis be a result of potassium channel dysfunction? *Neurosci Biobehav Rev* 36:960–968.
- Watis L, Chen SH, Chua HC, Chong SA, Sim K (2008) Glutamatergic abnormalities of the thalamus in schizophrenia: a systematic review. *J Neural Transm* 115:493–511.
- Wenzel A, Fritschy JM, Mohler H, Benke D (1997) NMDA receptor heterogeneity during postnatal development of the rat brain: differential expression of the NR2A, NR2B, and NR2C subunit proteins. *J Neurochem* 68:469–478.
- Woo TUW, Kim AM, Viscidi E (2008) Disease-specific alterations in glutamatergic neurotransmission on inhibitory interneurons in the prefrontal cortex in schizophrenia. *Brain Res* 1218:267–277.
- Wood J, Kim Y, Moghaddam B (2012) Disruption of prefrontal cortex large scale neuronal activity by different classes of psychotomimetic drugs. *J Neurosci* 32:3022–3031.
- Zhang Y, Behrens MM, Lisman JE (2008) Prolonged exposure to NMDAR antagonist suppresses inhibitory synaptic transmission in prefrontal cortex. *J Neurophysiol* 100:959–965.
- Zhang Y, Llinas RR, Lisman JE (2009) Inhibition of NMDARs in the nucleus reticularis of the thalamus produces delta frequency bursting. *Front Neural Circuits* 3:20.
- Zhang Y, Yoshida T, Katz DB, Lisman JE (2012) NMDAR antagonist action in thalamus imposes delta oscillations on the hippocampus. *J Neurophysiol* 107:3181–3189.