

# Biotic interaction between spionid polychaetes and bouchardiid brachiopods: Paleoecological, taphonomic and evolutionary implications

SABRINA C. RODRIGUES, MARCELLO G. SIMÕES, MICHAŁ KOWALEWSKI, MÔNICA A.V. PETTI, EDMUNDO F. NONATO, SERGIO MARTINEZ, and CLAUDIA JULIA DEL RIO



Rodrigues, S.C., Simões, M.G., Kowalewski, M., Petti, M.A.V., Nonato, E.F., Martinez, S., and del Rio, C.J. 2008. Biotic interaction between spionid polychaetes and bouchardiid brachiopods: Paleoecological, taphonomic and evolutionary implications. *Acta Palaeontologica Polonica* 53 (4): 657–668.

Shells of *Bouchardia rosea* (Brachiopoda, Rhynchonelliformea) are abundant in Late Holocene death assemblages of the Ubatuba Bight, Brazil, SW Atlantic. This genus is also known from multiple localities in the Cenozoic fossil record of South America. A total of 1211 valves of *B. rosea*, 2086 shells of sympatric bivalve mollusks (14 nearshore localities ranging in depth from 0 to 30 m), 80 shells of *Bouchardia zitteli*, San Julián Formation, Paleogene, Argentina, and 135 shells of *Bouchardia transplatina*, Camacho Formation, Neogene, Uruguay were examined for bioerosion traces. All examined bouchardiid shells represent shallow-water, subtropical marine settings. Out of 1211 brachiopod shells of *B. rosea*, 1201 represent dead individuals. A total of 149 dead specimens displayed polychaete traces (*Caulostrepsis*). Live polychaetes were found inside *Caulostrepsis* borings in 10 life-collected brachiopods, indicating a syn-vivo interaction (*Caulostrepsis* traces in dead shells of *B. rosea* were always empty). The long and coiled peristomial palps, large chaetae on both sides of the 5<sup>th</sup> segment, and flanged pygidium found in the polychaetes are characteristic of the polychaete genus *Polydora* (Spionidae). The fact that 100% of the *Caulostrepsis* found in living brachiopods were still inhabited by the trace-making spionids, whereas none was found in dead hosts, implies active biotic interaction between the two living organisms rather than colonization of dead brachiopod shells. The absence of blisters, the lack of valve/site stereotypy, and the fact that tubes open only externally are all suggestive of a commensal relationship. These data document a new host group (bouchardiid rhynchonelliform brachiopods) with which spionids can interact (interestingly, spionid-infested sympatric bivalves have not been found in the study area despite extensive sampling). The syn-vivo interaction indicates that substantial bioerosion may occur when the host is alive. Thus, the presence of such bioerosion traces on fossil shells need not imply a prolonged post-mortem exposure of shells on the sea floor. Also, none of the Paleogene and Neogene *Bouchardia* species included any ichnological evidence for spionid infestation. This indicates that the Spionidae/ *Bouchardia* association may be geologically young, although the lack of older records may also reflect limited sampling and/or taphonomic biases.

Key words: Brachiopoda, Spionidae, *Caulostrepsis*, *Bouchardia*, biotic interaction, bioerosion, Cenozoic, Brazil.

Sabrina Rodrigues [scoelho@ibb.unesp.br], Marcello Simões [btsimoes@ibb.unesp.br], Departamento de Zoologia, Instituto de Biociências Distrito de Rubião Júnior s/n CxP 510 18618-000 Botucatu, SP Brazil;

Michał Kowalewski [michalk@vt.edu], Department of Geosciences, Virginia Polytechnic Institute and State University Blacksburg, USA;

Mônica Petti [mapetti@usp.br], Edmundo Nonato [efnonnato@io.usp.br], Departamento de Oceanografia Biológica, Instituto Oceanográfico, Praça do Oceanográfico, 191 05508-120 São Paulo, SP Brazil;

Sergio Martinez [smart@fcien.edu.uy], Facultad de Ciencias, Inguá 4225, 11400 Montevideo, Uruguay;

Claudia del Rio [cdelrio@macn.gov.ar], Museo Argentino de Ciencias Naturales Bernardino Rivadavia, División Paleoinvertebrados, Angel Gallardo 470, Buenos Aires, Argentina.

## Introduction

*Bouchardia rosea* (Mawe, 1823), an endemic, free-living brachiopod, epifaunal or quase-infaunal is patchily distributed, but often abundant in the death assemblages of the southern Brazilian shelf (Tommasi 1970; Kowalewski et al. 2002; Simões et al. 2004a). On the Brazilian inner shelf, a region mainly dominated by siliciclastic bottoms, largely devoid of hard substrates (Mahiques et al. 1998, 2004; Rodri-

gues et al. 2002), *B. rosea* shells represent an important substrate for boring and encrusting organisms through the Holocene (Rodland et al. 2004, 2006; Simões et al. 2007a).

Although *Bouchardia rosea* is the only extant member of the Bouchardioidea (MacKinnon and Lee 2006), the fossil record of the genus can be traced back all the way to the Cretaceous/Paleocene boundary in the southern hemisphere (Manceñido and Griffin 1988). In fact, *Bouchardia* shells have been documented in multiple fossil benthic associations

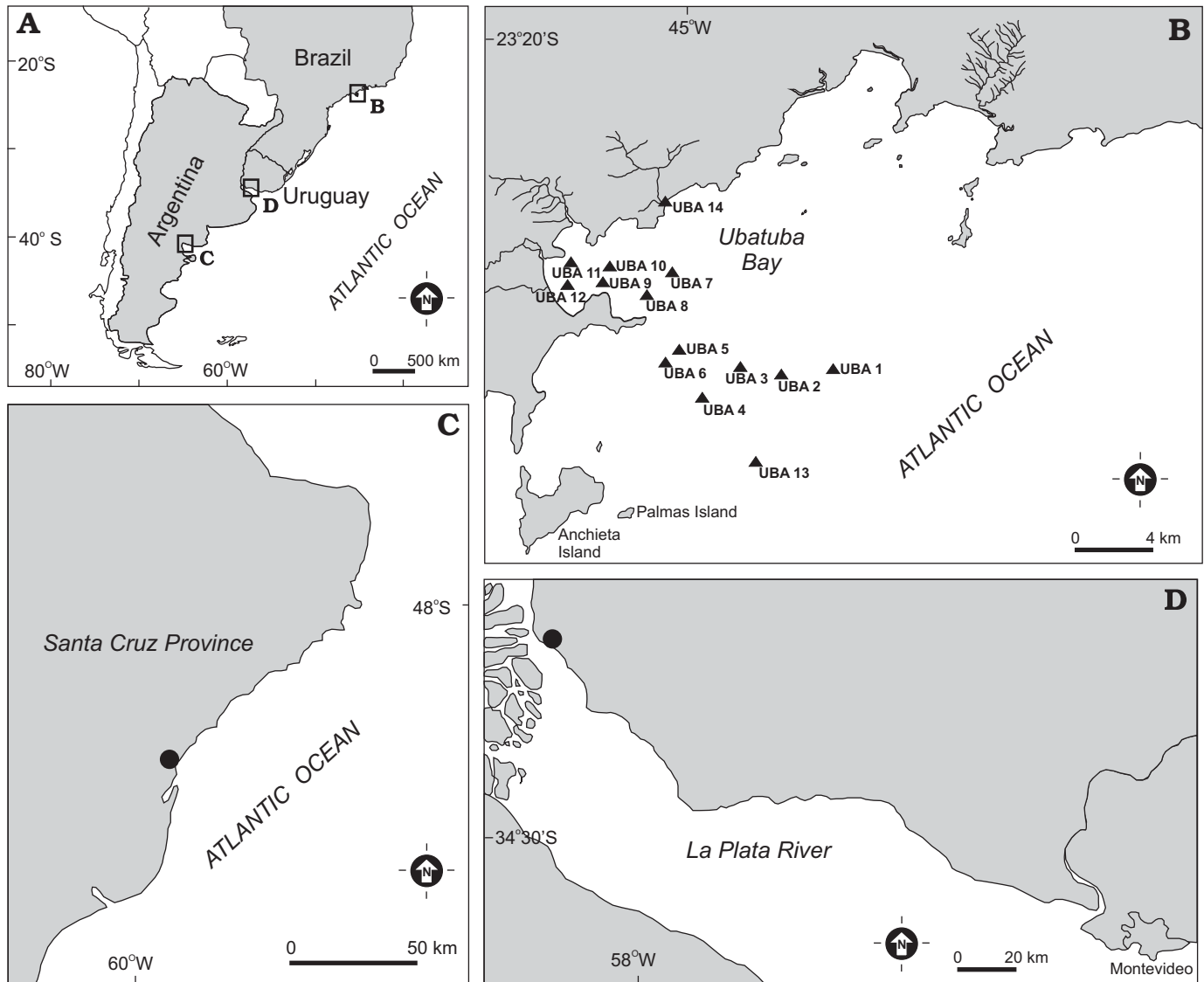

Fig. 1. A schematic map of the study area (A), including present-day sites along the northern coast of São Paulo State (Brazil) (B) as well as the sampled fossil localities in Argentina (C) and Uruguay (D).

of South America, including Paleogene (San Julián Formation, Patagonia, Argentina) and Neogene (Camacho Formation, Uruguay) localities. In these geological units, *Bouchardia*-rich accumulations are found in subtropical marine provinces ranging from intertidal to mid-shelf depositional settings. Consequently, *Bouchardia* shells represent a suitable target for studying long-term patterns in biotic interactions between brachiopods and boring organisms across similar—subtropical and predominately shallow-water—marine ecosystems of the Cenozoic South America.

This study aims to: (i) evaluate the identity of the primary bioeroder in living brachiopod shells and discuss possible ecological interpretations of this interaction; (ii) describe the traces left by the bioeroders in brachiopod shells to enhance our ability to recognize such traces in the fossil record and/or in shells found in Holocene death assemblages; (iii) estimate the trace frequencies for the extant (*Bouchardia rosea*) and

fossil *B. zitteli* and *B. transplatina* species; (iv) compare trace frequencies on Holocene brachiopod shells with sympatric bivalve mollusks; and (v) assess the effect of the bioerosion on the taphonomic behavior of shells of *B. rosea*.

*Institutional abbreviations.*—DZP, Departamento de Zoologia, Instituto de Biociências, Universidade Estadual Paulista, Brazil; FCDP, Departamento de Paleontología, Facultad de Ciencias, Uruguay; IGC-DPE, Departamento de Geología Sedimentar e Ambiental, Instituto de Geociências, Universidade de São Paulo, Brazil.

## Historical background

As will be discussed in detail below, all borings found in *Bouchardia* shells are referable to *Caulostrepsis*. This trace

is known from numerous rockgrounds and shells from the Devonian to Holocene (see Taylor and Wilson 2003 for a review). As commented by Bromley (1978, 1994), *Caulostrepsis* and its various ichnospecies (e.g., *C. taeniola*, *C. cretacea*) are most likely to record euendolithic or paraendolithic activities of polychaete annelids of various families, in particular spionid polychaetes (Barrier and D'Alessandro 1985). Although *Caulostrepsis* is known from shells of rhynchonelliform brachiopods as old as the Devonian, the trace is much better documented for Holocene and fossil mollusk shells (see Taylor and Wilson 2003 and references therein). In fact, this type of trace has been commonly found in mollusk shells elsewhere (e.g., Bromley and D'Alessandro 1983; Pickerill et al. 1998, 2002; Taylor and Wilson 2003; Lorenzo and Verde 2004; Parras and Casadío 2006). As far as we know, *Caulostrepsis* has not been documented and/or figured for any shell of *Bouchardia* species.

## Geological setting

***Bouchardia rosea* shell accumulations.**—Brachiopods and mollusks co-occur at many sites along coastal intertidal to the deep subtidal shelf of the Ubatuba Bight, state of São Paulo, in the Southeast Brazilian Shelf (Fig. 1). The Ubatuba Bight is characterized by a series of small sedimentary plains delineated by igneous and metamorphic promontories. Continental and transgressive marine Pleistocene and Holocene deposits form these plains (Martin and Suguio 1976; Suguio and Martin 1976; Suguio et al. 1993; Martin et al. 1996; Suguio 1999). The Ubatuba Bight has an average water depth of 10 m and a total area of nearly 8 km<sup>2</sup>. The bight faces to the east and is therefore protected against the prevailing S-SW trade winds and high-energy waves (Mahiques et al. 1998). However, Ubatuba Bight is influenced by warm waters of the South Brazil Current. The following annual mean values have been reported for the bight waters: temperature: 23.8°C, salinity: 33.2‰, and dissolved oxygen: 5.11 mg/l (Mantelatto and Fransozo 1999).

Sedimentation rate is considered negligible in the Ubatuba Bight (Magliocca and Kutner 1965; Simões et al. 2004b). Fine-grained (silt and very fine sand), terrigenous sediments, including an admixture of terrestrial organic matter, characterize the bight bottoms (Mantelatto and Fransozo 1999). Surficial sediments may contain abundant biogenic fragments, including brachiopod *Bouchardia rosea* (Fig. 3), mollusks, echinoids, bryozoans, and foraminifers. However, these are patchily distributed in the area, preferentially occurring in the outer portions of the bight (Mahiques et al. 1998; Mantelatto and Fransozo 1999; Carroll et al. 2003; Rodland et al. 2004, 2006; Rodrigues 2006).

**Paleogene *Bouchardia zitteli* shells.**—The South Atlantic transgressions in the Eastern sector of the Austral Basin in southern Patagonia (Argentina) across the Paleogene/Neogene boundary generated several shallow fossil-rich marine deposits grouped under the informal name of the “Patagonian

horizons”, named at the beginning of the 20<sup>th</sup> century. These horizons were subsequently placed in the San Julián Formation and Monte León Formation (Bertels 1970). Ihering (1907) placed the fossiliferous horizons exposed in Manantial Salado locality in the basal section of the “Patagonian beds” (Fig. 2), but it is not clear from his paper (Ihering 1907), or from indications of labels of his collection, if that locality is situated in the Bajo de San Julián itself or in the vicinities of the area where both the Early Miocene Monte León Formation and the San Julián Formation (Meseta Chica and Gran Bajo Members) are exposed.

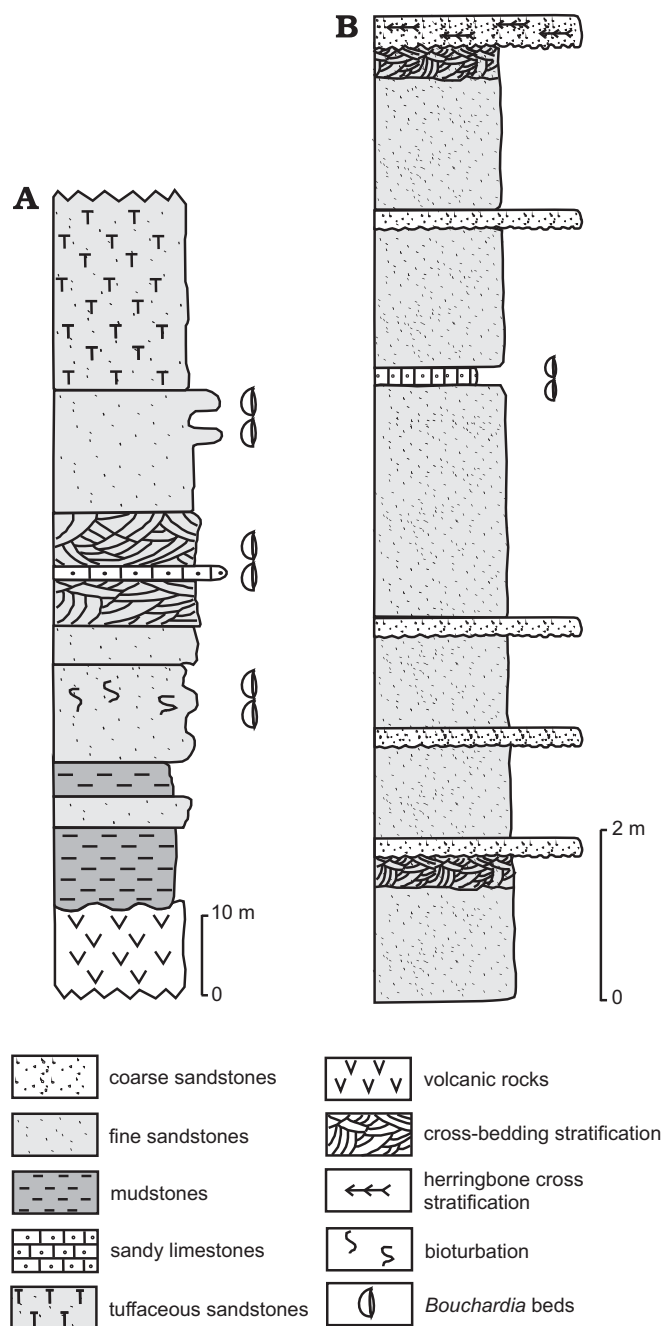

Fig. 2. Schematic stratigraphic sections of the studied fossil localities in Bajo de San Julián, Argentina (A) and Cerro Bautista, Uruguay (B), showing the *Bouchardia*-beds.

Following the early work, no future references to Manantial Salado locality has been made by subsequent researchers working in the region. However, some other localities in the Bajo San Julián–Puerto San Julián' area where *Bouchardia zitteli* has been recorded were reported by del Río (2004) as representing the San Julián Formation (upper and lower members). The brachiopods in this unit are associated with the echinoids *Iheringiella patagonensis* and with the *Panopea sierrana*–*Parynomys patagonensis* bivalve assemblage (del Río 2004). The San Julián Formation, in its type area in the Bajo San Julián, has been considered of Late Eocene age (Camacho 1974), late Eocene–Oligocene (Bertels 1977), while the uppermost horizons have been placed in the Oligocene (Barreda 1997) (see del Río 2004 for a discussion of age).

**Neogene *Bouchardia transplatina* shells.**—During the Neogene (Miocene), large areas of the southern region of South America, including Argentina, Uruguay, and Brazil were flooded by the “Enterriense” transgressions. Fossil-rich deposits are known in Argentina (Puerto Madryn Formation in northeastern Patagonia and Paraná Formation in the Entre

Rios Province), along the Uruguayan coast in the Colonia and San José Departments (Camacho Formation), and in the southernmost Brazil (Pelotas Basin, the state of Rio Grande do Sul) (Martínez and del Río 2002). Rocks of Camacho Formation are Late Miocene in age (Figueiras and Broggi 1971; Herbst and Zabert 1987; Scasso et al. 2001). These include fine to medium sandstones, silty sandstones, fossil-rich limestones, which were deposited in intertidal, foreshore, and mid-shelf settings. In the Cerro Bautista locality, Uruguay, proximal tempestites are characterized by highly diverse and abundant shelly concentrations (Fig. 2). These are dominated by mollusks, brachiopod *Bouchardia transplatina* (Fig. 3) and balanomorphs (Martínez 1994).

## Materials and methods

Bulk samples included a total of 1211 valves of *Bouchardia rosea* (Fig. 3) collected from 14 nearshore localities (depth range: 0–30 m) in the general area of Ubatuba Bight (Fig. 1). For all sampling stations, surficial sediments were collected using a Van Veen grab sampler (1/40 m<sup>3</sup>) and otter-trawl nets with an anchor dredge. This allowed us to acquire the uppermost several centimeters of bottom sediments, with sample volume totaling at least 8 liters of bottom sediments. The samples were wet-sieved, throughout 8-mm to 2-mm mesh sizes, and air-dried. Brachiopod samples consisted of dead, empty shells and rare specimens collected alive. Following sieving, all living brachiopods (only 10 specimens) were stored in 70% ethanol.

To assess the geological record of trace fossils on *Bouchardia* shells, the paleontological materials repositied in two scientific collections were examined. In the first collection, housed in IGC-DPE, we identified 80 specimens of *Bouchardia zitteli* (Fig. 3) from Manantial Salado locality, San Julián Formation (Oligocene), Argentina. Most (68.7%, n = 55) of these specimens are articulated, and non-fragmented, although they sometimes show evidence (e.g., granular shell texture, pits) for chemical dissolution. In the second collection, housed in FCDP, 135 specimens of *B. transplatina* (Fig. 3) were studied. These fossils came from Cerro Bautista locality, Camacho Formation (Late Miocene), and are represented by complete, mainly disarticulated (80%, n = 108), and recrystallized shells.

Shells of *B. rosea*, *B. zitteli*, and *B. transplatina* were counted and analyzed under the stereomicroscope for the presence of *Caulostrepsis* Clarke, 1908. Both wall-exposed traces and tube openings (Fig. 4) were considered as referable to *Caulostrepsis*. All infested shells were digitally imaged under high magnification, and imported into Corel Draw (version 12) for the trace measurements. Also, selected specimens were examined under the SEM. The three standard dimensions of brachiopod shells (length, width, and thickness) were measured with electronic caliper to the nearest 0.1mm. In the case of Holocene shelly accumulations from the Ubatuba Bight, the same procedure was followed

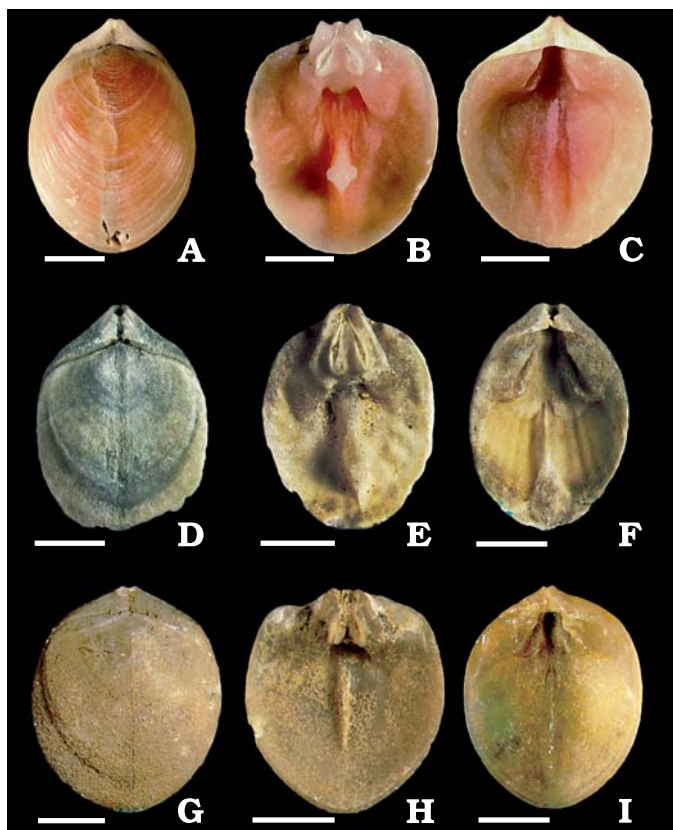

Fig. 3. General shell morphology of bouchardiid brachiopods. A–C. *Bouchardia rosea* (Mawe, 1823) from modern accumulations from the Ubatuba coast, State of São Paulo, Brazil. A. Specimen DZP-18669. B. Specimen DZP-18670. C. Specimen DZP-18671. D–F. *Bouchardia transplatina* Ihering, 1907 from the Cerro Bautista locality, the Camacho Formation, Late Miocene, Uruguay. D. Specimen FCDP-2305E. E. Specimen FCDP-2305G. F. Specimen FCDP-2305K. G–I. *Bouchardia zitteli* Ihering, 1897 from the Manantial Salado locality, the San Julián Formation, Late Oligocene, Argentina. G. Specimen IGC-DPE-855D. H. Specimen IGC-DPE-865H. I. Specimen IGC-DPE-865N. Scale bars 5 mm.

for all bivalve mollusks that co-occurred with *Bouchardia rosea*. When possible, bivalve specimens were identified to genus level, based on the relevant taxonomic lists (e.g., Abbott and Dance 1982; Ríos 1994).

Trace frequencies for both modern and fossil brachiopods, as well as sympatric bivalve mollusks were computed by dividing number of disarticulated valves by two (see Kowalewski 2002 for a discussion of how to correct frequency of single traces for bivalved host organisms). Comparisons of trace frequencies are presented according to the (i) collecting sites; (ii) shell size; (iii) valve type; (iv) occurrences on shells of co-occurring groups of organisms (*Bouchardia rosea* and bivalve mollusks), and (v) occurrences within *Bouchardia*, throughout the sampled geological record (Late Oligocene, Late Miocene, and Late Holocene).

## Results

**Borings in *Bouchardia rosea*.**—Modern (living and empty) shells of *Bouchardia rosea* typically show boring traces referable to the ichnogenus *Caulostrepsis* (Fig. 4). Traces are organized as U-shaped galleries, with the limbs of the U being more or less straight longitudinally, quite closely together, and parallel to the plane defined by the inner (or outer) surface of the brachiopod shell (euendolithic penetration). In unroofed or roof-less specimens, the sides of the tube are deeper than the middle, resulting in a typical central elongated ridge. Hence, the space between the limbs is open but narrower, so that the cross-sectional tube morphology looks like a broad-centered figure-of-eight morphology. Both gallery openings communicate only with the outer surface of the shells and do not come into contact with the internal soft parts of the host shell. In many cases, the gallery can extend over the entire length of the brachiopod shell (Fig. 4). Typically, more than one gallery may be present, but never more than 3 on a single host valve (Fig. 4). Maximum observed trace length was 17.15 mm, and the maximum width was 2.0 mm. For all specimens, the width of the tubes tends to be approximately constant along their long axis.

Polychaetes found inside the borings in association with living specimens of *Bouchardia rosea* are characterized by long and coiled peristomial palps stretching out of the tube. Large chaetae are present on both sides of the 5<sup>th</sup> segment and a flanged pygidium is also observed (Fig. 5). All specimens of *Bouchardia rosea* (10 specimens) collected alive were infested by living polychaetes, as described above. However, none of the 149 dead *Bouchardia rosea* shells bearing corresponding traces showed any living polychaetes inside the borings.

Trace frequency in brachiopods was 24.8%, and varied by collecting site, with values ranging substantially across sampling stations: 10.3% (Station UBA5, 20 m water depth, Table 1), 20.3% (Station UBA9, 10 m water depth, Table 1), 27.7% (Station UBA1, 30 m water depth, Table 1), and 53.1% (Station UBA4, 25 m water depth, Table 1). A notable

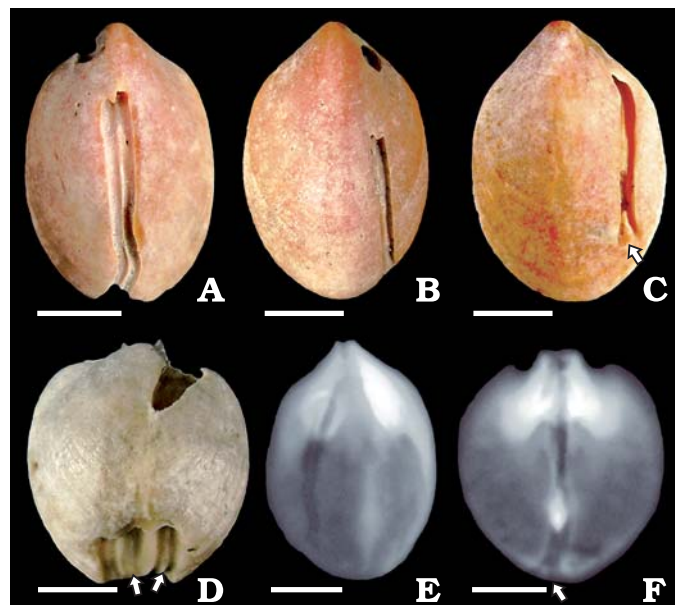

Fig. 4. Bioerosion trace *Caulostrepsis*. A. Specimen DZP-18422, ventral valve of *Bouchardia rosea* showing the typical morphology of *Caulostrepsis*. Note the well-developed central ridge, and the straight morphology of the trace. B, C. Specimens DZP-18423 and 18424, respectively. Note that the galleries are roughly straight, and not enlarged at their distal extremities. The apertural groove (arrow) is well marked. D. Specimen DZP-18425, dorsal valve, showing multiple (arrows), straight traces. E, F. X-ray images of the specimens DZP-18426 and 18427, respectively. Note the straight morphology of unabraded tubes and the apertural groove (arrow) in the specimen DZP-18427. Scale bars 5 mm.

increase in trace frequencies can be observed with increase in the host shell size. For example, when shells were grouped in terms of their maximum length (from small to large into three categories >8 mm, 8–6 mm, and 6–2 mm), trace frequencies were 40.4%, 25.6%, and 19.4%, respectively (Table 2). This pattern persisted when trace frequencies were analyzed for those shell size classes separately for 4 out of 5 collecting sites (Station UBA5 was the only exception).

Pooling the data by valve type, trace frequencies of 28.6% and 18.0% were observed for dorsal and ventral valves, respectively (Table 3). However, the relation is variable across stations. Dorsal valves showed higher trace frequencies than ventral valves in some of the collecting stations (Stations

Table 1. Number of infested and non-infested, live and dead *Bouchardia rosea* shells per collecting sites. Trace frequency (TF) estimated by sampling sites. Abbreviations: Frag., fragmentation rates; Inf., infested shells; TF, trace frequency.

Collecting sites		Living specimens			Dead shells			
Station	Depth (m)	Total	Inf.	TF (%)	Total	Inf.	TF (%)	Frag. (%)
UBA 1	30	0	–	–	451	62	27.7	23.7
UBA 4	25	0	–	–	113	30	53.1	43.4
UBA 5	20	0	–	–	155	8	10.3	34.2
UBA 9	10	10	10	100	482	49	20.3	34.6
Total		10	10	100	1201	149	24.8	45.6

Table 2. Number of infested and non-infested dead *Bouchardia rosea* shells per collecting sites and size categories. Abbreviations: Inf., infested shells; TF, trace frequency.

Collecting sites		Dead shells >8 mm			Dead shells 8–6 mm			Dead shells 6–2 mm		
Station	Depth (m)	Total	Inf.	TF (%)	Total	Inf.	TF (%)	Total	Inf.	TF (%)
UBA 1	30	3	1	66.6	214	35	32.6	234	26	22.2
UBA 4	25	11	3	54.5	25	6	48	77	21	54.6
UBA 5	20	0	–	–	5	0	0	150	8	10.6
UBA 9	10	179	35	39.1	153	10	13	150	4	5.2
Total		193	39	40.4	397	51	25.6	611	59	19.4

Table 3. Number of infested and non-infested dead *Bouchardia rosea* shells per collecting sites and valve type. Fragmentation rates are also indicated. Abbreviations: Frag., fragmentation rates; Inf., infested shells; TF, trace frequency.

Collecting sites			Dorsal valves			Ventral valves		
Station	Depth (m)	Frag. (%)	Total	Inf.	TF (%)	Total	Inf.	TF (%)
UBA 1	30	23.7	368	57	31.0	83	5	12.0
UBA 4	25	43.4	61	17	55.8	52	13	50.0
UBA 5	20	34.2	39	4	20.6	116	4	6.8
UBA 9	10	34.6	300	32	21.4	182	17	18.6
Total			768	110	28.6	433	39	18.0

Table 4. Data for Paleogene and Neogene *Bouchardia* shells. Abbreviations: Art., articulated shell; Frag., fragmentation rate; TF, trace frequency.

Taxon	Total	Size (mm)			Valve type (%)			Frag. (%)	TF (%)
		mean	min	max	Art.	dorsal	ventral		
<i>B. zitteli</i>	80	13.9	3.3	19.1	68.7	17.5	13.8	16.3	0
<i>B. transplatina</i>	135	14.5	7.9	20.4	20.0	43.7	36.3	0.7	0

UBA1 and UBA5). On the other hand, comparable trace frequencies for dorsal and ventral valves were observed for specimens collected from Station UBA9 and UBA4 (see Table 3 for details).

**Holocene sympatric mollusk bivalve shells.**—In total 2086 bivalve valves, from the same collecting stations that yielded *Bouchardia rosea* shells, were examined for the occurrence, distribution, and density of *Caulostrepsis* traces. The bivalve mollusk specimens were randomly chosen. They represent 36 genera, including 25 infaunal genera (731 shells), 2 semi-infaunal genera (64 shells), 9 epifaunal genera (282 shells), and 1009 unidentifiable shells (Appendix 1). Although drill holes (Simões et al. 2007a) and encrusting organisms (Rodrigues 2006) are common in those shells, no traces referable to *Caulostrepsis* were identified in the sympatric mollusk bivalve shells of the Ubatuba Bight.

**Paleogene and Neogene *Bouchardia* shells.**—A total of 80 specimens of *Bouchardia zitteli* of San Julián Formation

(Late Oligocene, Argentina), and 135 shells of *B. transplatina* of Camacho Formation (Late Miocene, Uruguay) were also studied (Table 4). For *B. zitteli*, shell size ranged from 3.3 mm to 19.1 mm (Table 4). Considering the same standard size classes, as used above for *B. rosea* shells for this species, 93.7% (n = 75) of the shells are in >8 mm class; 5% (n = 4) in 8–6 mm class, and 1.3% (n = 1) in 6–2 mm class. Among *B. transplatina* shells, specimens were only grouped in the >8 mm (99.2%, n = 134), and 8–6 mm (0.8%, n = 1) size classes, with shell size ranging from 7.9 mm to 20.4 mm (Table 4). For both fossil species, ventral and dorsal valves were well represented in the studied collections. In *B. zitteli*, 13.7% (n = 11) were ventral valves and 17.6% (n = 14) were dorsal valves, being 68.7% (n = 55) articulated specimens. In *B. transplatina*, 36.3% (n = 49) were ventral valves, 43.7% (n = 59) were dorsal valves, and 20% (n = 27) were articulated specimens. Both, *B. zitteli* and *B. transplatina* are devoid of *Caulostrepsis* traces (Table 4).

## Discussion

**Bioeroder identity.**—U-shaped pouched-like traces (*Caulostrepsis*) are produced by several families of polychaetes (e.g., Bromley 1994; Parras and Casadío 2006). For example, Spionidae (polydorid) polychaetes are known to produce *Caulostrepsis* (Bromley 1994; Taylor and Wilson 2003). However, Bromley (1978) has suggested that such traces can be made by Eunicidae polychaetes. Our in vivo observations of polychaetes inside the shells provide direct evidence that definitive (and not just incipient, see Taylor and Wilson 2003) *Caulostrepsis* can also be produced by spionid polychaetes (see also Wisshak and Neumann 2006). The long and coiled peristomial palps, the large chaetae present on both sides of the 5<sup>th</sup> segment, and the flanged pygidium (Fig. 5) are all consistent with *Polydora* sp. (Spionidae).

Among the spionids, 35 species are known to have relationships with diverse invertebrate hosts, including mollusks, sponges, cnidarians, cirripeds, bryozoans, and coral-line algae (Blake and Evans 1973).

Data presented here add to the very limited literature documenting that rhynchonelliform brachiopods can act as host for spionids. Until now, *Lingula*, *Terebratalia transversa*, *Terebratulina unguicula*, and *Laqueus californianus* were the other known extant brachiopods that may be infested by polychaetes (Hammond 1984; Rodrigues 2007).

**Trace morphology.**—The trace morphology is similar to that of *Caulostrepsis taeniola* and *C. cretacea* in having a comparable pouch structure (see Bromley and D'Alessandro 1983: 297, fig. 7). However, traces found in shells of *Bouchardia rosea* are morphologically much simpler (Fig. 6) than those described by Bromley and D'Alessandro (1983). Namely, the difference between the *Caulostrepsis* in *Bouchardia rosea* shells and *C. taeniola* (typically found in bivalve mollusk shells, among others) is that in the latter the

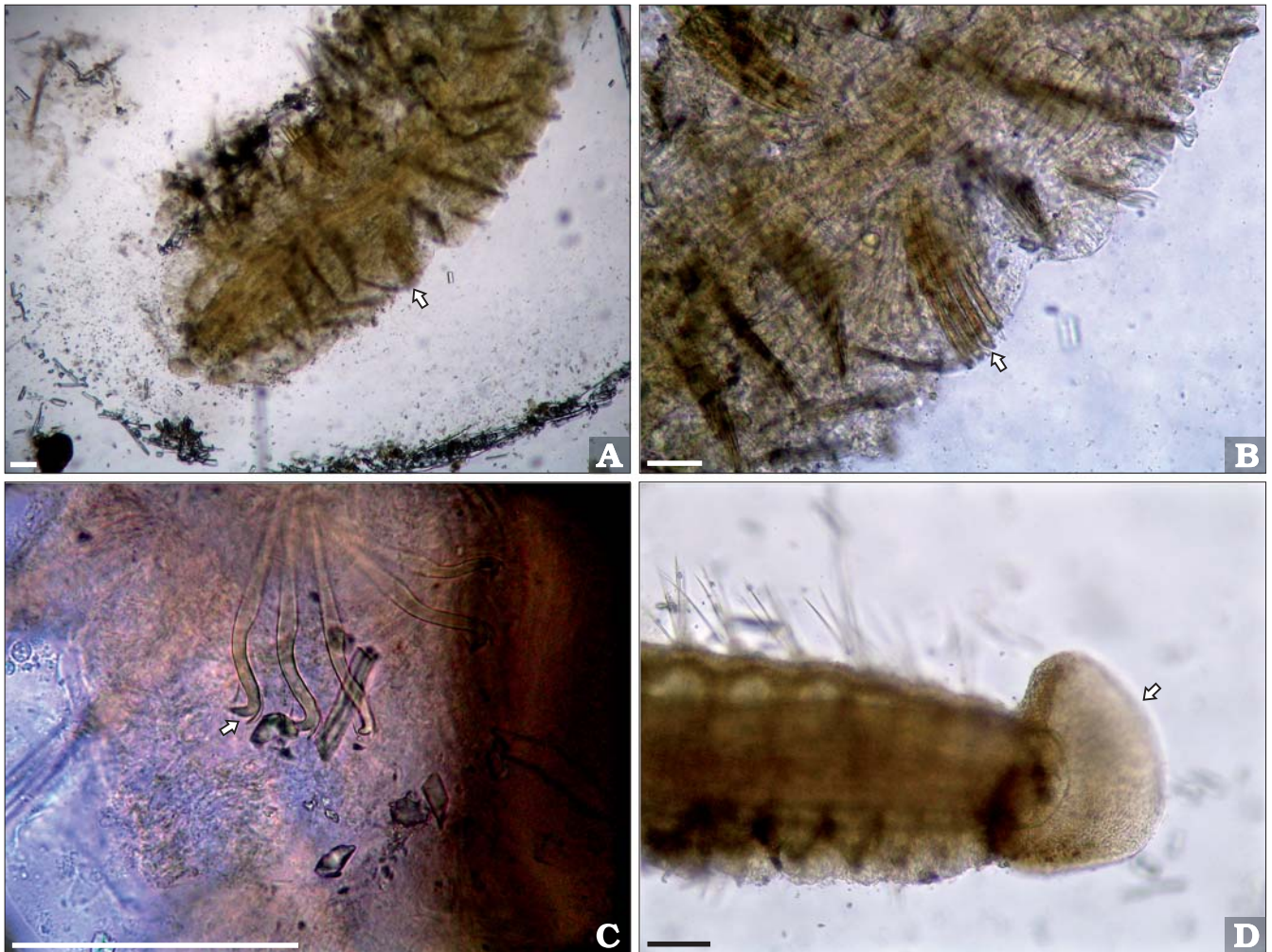

Fig. 5. Spionid polychaete *Polydora* sp. found in association with *Bouchardia rosea* shells, Ubatuba Bight, 10 and 20 m depth. Specimen DZP-18668. **A, B.** Anterior segments of *Polydora* showing the characteristic modified chaetae (arrows) in its 5<sup>th</sup> segment. **C.** *Polydora* hooks (arrow) from the median segments. **D.** Posterior segments of *Polydora* showing the flanged pygidium (arrow). Scale bars 100 µm.

cross sectional shape varied from flat-oval, elliptical or constricted to dumbbell (see Bromley and D'Alessandro 1983: 297, fig. 7), and in the former only a figure-of-eight morphology was present along the whole trace (Fig. 6). However, in some cases, the central ridge resulted from the fusion of the limbs was not preserved throughout the trace.

**The ecological interaction of the *Caulostrepsis* in *Bouchardia rosea*: the time of infestation.**—As commented above, none of the *Caulostrepsis* found in dead shells was inhabited by a polychaete (also, spionid soft tissues from a dead infester was not recovered from any of the dead shells). In addition, in all studied shells the tubes were located on the external side of the host valve, never inside the valve, and the tubes always opened to the outside of the shell. These observations suggest consistently that infestation events occurred preferentially when the host was still alive. As observed by Pickerill (1976), infestation of living host seems advantageous to some infestors, because such hosts provide better protection from overturning, breakage or abrasion relative to empty valves or shells.

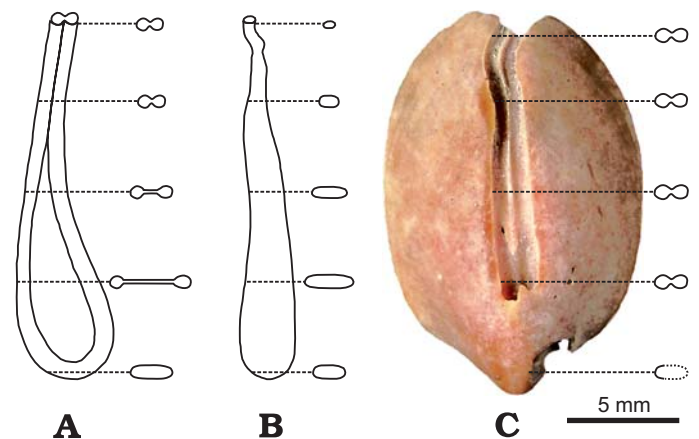

Fig. 6. Morphology of *Caulostrepsis*. **A, B.** Drawings of *Caulostrepsis taeniola* Clarke, 1908 (**A**) and *Caulostrepsis cretacea* (Voigt, 1971) (**B**), respectively. **C.** Morphology of *Caulostrepsis* traces found in *Bouchardia rosea* shells. Note differences in the cross-sectional morphology between the traces reported here (**C**) and those documented previously (**A, B**).

The syn-vivo infestation postulated here is consistent with similar data collected recently for the brachiopod fauna of San Juan Island (USA), Pacific Ocean (Rodrigues 2007). As for *B. rosea*, living shells of *Terebratalia transversa*, *Terebratulina unguicula*, and *Laqueus californianus* appear to be colonized by polychaetes only when they are alive. Similarly, none of polychaete traces opened inward, and the presence of blisters in shells of *Terebratalia transversa*, *Terebratulina unguicula*, and *Laqueus californianus* suggests strongly that the penetration occurred when those brachiopods were still alive (Rodrigues 2007). In the case of *B. rosea* shells, no blisters associated with *Caulostrepsis* were observed. However, it should be noted that the absence of blisters in this species is probably due to the thick-shelled nature (the secondary fibrous layer is very thick) of *Bouchardia rosea* shell; the Pacific shells are relatively much thinner. Our data are also consistent with multiple studies focused on other types of host. For example, Parras and Casadío (2006) demonstrated that polychaete borings (e.g., *Maeandropolydora*) in Paleocene and Neogene oysters were made while they were alive. Wisshak and Neumann (2006) suggested that *Caulostrepsis* traces in the Cretaceous (Early Maastrichtian) echinoid *Echinocorys ovata* are evidence of syn-vivo infestation of the oral surface of host shell by polydorid polychaetes. Finally, living specimens of bivalve mollusks (*Chione fluctifraga*) from Bahía Falsa, Baja California, and Bahía de Guásimas, Sonora, were kept in aquaria and also showed infestation by *Polydora* (Caceres-Martinez et al. 1999). These laboratory studies demonstrated that shell tubes were occupied by living polychaetes, most of the time located around the siphon area of the host shell. Although polychaetes were able to survive in recently dead shells, new infestations of dead hosts were not observed (Caceres-Martinez et al. 1999).

**The nature of the ecological interaction between *Caulostrepsis* and *Bouchardia rosea*.**—The high infestation rates (24.8%, pooled data) observed for *Bouchardia rosea* shells is consistent with the fact that spionid polychaetes are widespread and abundant in the study area (Paiva 1996; Petti 1997; Santos 1998; de Léo 2003; Amaral and Nallin 2004). In spite of the fact that brachiopod shells were bored by polychaetes when they were alive, it is difficult to determine if this ecological interaction represents commensal or parasitic relationship. In part, this is because studies dealing with the metabolic costs inflicted on brachiopods by infesting spionids are lacking. Additionally, all inferred cases of commensalism/parasitism involving rhynchonelliform brachiopods were based on indirect inferences. Nevertheless, some observations regarding the nature of the biotic interaction can be made.

A commensal rather than parasitic interaction seems to be more likely in the case of the *Polydora*–*Bouchardia rosea* interaction because of the mode of life of the hosting shell and the lack of valve and surface site stereotypy. As indicated by the data in Table 3, there is no preference (stereotypy) for the type of valve colonized by the borers. The high rates of trace observed on dorsal valves from Station UBA1 and Station UBA5 may be a taphonomic artifact, since these shell accu-

mulations include relatively few ventral valves comparing with dorsal ones (i.e., estimates of infestation frequencies are prone to have very large error due to a relatively smaller sample size of ventral valves). In general, brachiopod valve accumulations from most sites (Table 3) appear to have been affected by a bias favoring preservation of dorsal valves. This bias is, most likely, due to taphonomic processes such as hydrodynamic sorting and differential shell dissolution (Simões et al. 2007b). Indeed, in the case of a sample with equal proportion of ventral and dorsal shells (Station UBA4, Table 3), the trace frequencies per valve type is similar ( $TF_{\text{dorsal}} = 55.8\%$ ;  $TF_{\text{ventral}} = 50\%$ , Table 3).

As recently demonstrated by Rodrigues (2007), the brachiopod mode of live may play an important role in the stereotypy of the trace producers. For example, shells of *Terebratalia transversa*, *Terebratulina unguicula*, and *Laqueus californianus* collected from rocky and muddy substrates, from Pacific Ocean, around San Juan Islands (USA), exhibited traces preferentially distributed on ventral valves, even considering living specimens only (Rodrigues 2007). These brachiopods are epifaunal, sessile, attached to the substrate, lying on dorsal valve. Thus, ventral valves of living specimens offer the most advantageous location (maximally elevated above the sediment-water interface) for the settlement of a suspension-feeding infester (Rodrigues 2007). This mode of life contrasts with the free-living mode of *B. rosea*. Shells of this species are not firmly attached to the substrate (see Brunton 1996; Richardson 1981, 1987; Simões et al. 2004a, 2007a) and are prone to lateral transport and reworking. Hence, the similar rates of infestation for dorsal/ventral valves of *Bouchardia rosea* may reflect the free-living mode of life of this brachiopod.

In all 10 specimens of *B. rosea* collected alive, infesting polychaetes (*Polydora* sp.) were found in direct physical association with brachiopod shells, living inside *Caulostrepsis*. These traces were not observed in the sympatric mollusk bivalves. Hence, this interaction is not a result of a fortuitous encounter of polychaete larvae and the host brachiopod shell. The seafloors in the study area are devoid of large clasts and bioclasts. In many cases, dense accumulations of *B. rosea* shells (Simões et al. 2007b) are the main hard substrate available. Notably, the dense accumulations are near the islands and/or in other places (Station UBA9) characterized by locally high rates of primary productivity.

Given the notable-to-high frequencies of spionid-infested shells observed across Recent sites for *B. rosea*, the complete lack of evidence for such interactions in fossil specimens of *B. zitteli* and *B. transplatina* is intriguing. Especially when considering that these fossil occurrences represent similar climatic and environmental settings and the producers of *Caulostrepsis* are known to have been present in the Cenozoic ecosystems of the southern South America. Samples of the oyster *Crassostrea? hatcheri* from Paleogene deposits of Argentina (the San Julián Formation, Late Oligocene), show very high frequencies (97%) of *Caulostrepsis* and *Maeandropolydora* traces (Parras and Casadio 2006). Comparably high frequencies were reported for oysters recovered from the Centinela



Formation (Early Miocene) from Argentina (Parras and Casadio 2006). Additionally, *Caulostrepsis* is a common trace in mollusk shells of Neogene rocks from the Uruguay (Lorenzo and Verde 2004), including bivalve shells of the Camacho Formation (Late Miocene, Mariano Verde personal communication 2005), a unit known to contain *Bouchardia*-dominated shell beds.

Given the absence of infested shells in fossil brachiopods, at least on shells of those considered scientific collections, and the absence of infested bivalve shells co-occurring with infested bouchardiid shells in the Holocene, it is possible that the spionid-brachiopod interaction may represent an evolutionarily recent development. In addition, observations on the Eocene *Bouchardia antarctica* shells can support this interpretation, due to the lack of any trace of spionid-brachiopod interaction on over 300 specimens (Bitner 1996; Maria A. Bitner, personal communication 2008). However, given the limited scope of our fossil data, both in terms of the number of fossil specimens examined and the number of fossil sites sampled, the absence of polychaete traces may reflect inadequate sampling. Further studies are required, especially in the younger part of the Neogene to evaluate the putative hypothesis that the spionid-brachiopod interaction is geologically recent.

Regardless of its geological history, frequent spionid infestations of *B. rosea* cannot be viewed as a geographically local, spatially unique phenomenon restricted to the Ubatuba Bight: *Bouchardia rosea* shells found in the Santos Bight (~100 kilometers south of the study area) and at the Maricá Beach, Rio de Janeiro coast (~187 kilometers northward of the study area) also often bear *Caulostrepsis* traces (Rodrigues and Simões 2007, SCR personal observation).

Finally, the spionid-brachiopod interaction here described may represent a very specific biotic relationship, since *Caulostrepsis* traces are not recorded on shells of other co-occurring benthos.

#### Taphonomic implications of *Caulostrepsis* in brachiopod shells.

—In their exhaustive review of the fragmentation of bioclastic materials, Zuschin et al. (2003) showed that multiple factors are responsible for shell fragmentation in different sedimentary settings. For example, fragmentation may be due to ecological interactions, as a result of feeding activities among members of a given community (Zuschin et al. 2003). Drilling, chipping, crushing, peeling, rasping, breaking, and microbioerosion of hard parts are some of the damages produced on shelly organisms by gastropods, calappid crabs, spiny lobsters, fishes, birds (oystercatchers), cyanobacteria, algae, fungi, and many other biological agents. These interactions may weaken shells making the resulting bioclasts more prone to fragmentation (Zuschin et al. 2003: 59). However, fragmentation induced by ecological processes is difficult to recognize in death and fossil assemblages, because resistance to lethal damage by durophagous predators often cannot be directly assessed (see Zuschin et al. 2003, for a review). However, in the case of *B. rosea* shells, patterns of shell breakage may be linked to a specific causative agent. Namely, in the

Ubatuba Bight, some shell fragments of *B. rosea* are clearly the result of breakage along the surface defined by polychaete tubes (*Caulostrepsis*), especially when the trace was located near the maximally convex part of the shell (Fig. 7).

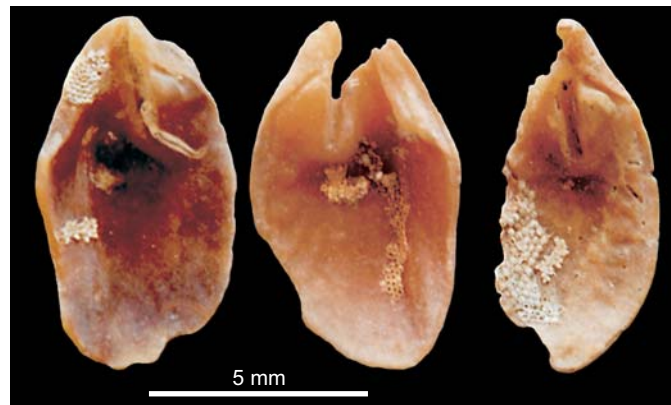

Fig. 7. Fragments of *Bouchardia rosea* (Mawe, 1823) shells resulting from the breakage along the surface defined by polychaete tubes.

It is noteworthy that the highest frequency of infested shells observed at Station UBA4 (53.1%) is more likely to be a consequence of higher level of taphonomic alteration at this site than a reflection of elevated rates of biological infestation. That is, spionid traces tend to be much more difficult to detect in unaltered *Bouchardia rosea* shells (see X-ray of fresh shells; Fig. 4) because infestation of pristine shells is only manifested by their small tube openings. In contrast, heavily abraded/corroded shells and shell fragments broken along the trace facilitate identification by making *Caulostrepsis* well-exposed and often marked by its distinct central ridge structure (Fig. 4). In this context, it is noteworthy that Station UBA4, where *Bouchardia* shell fragments are very common (43.4%; Table 3), is also the site that yielded the highest frequencies of polychaete borings (53.1%; Table 1). Thus, the infested *B. rosea* shells offer an example of an interesting taphonomic feedback, where traces induce biological facilitated fragmentation, but that fragmentation occurs along the trace facilitating detection and identification of the ecological information represented by *Caulostrepsis* (Fig. 7). Such fragments, if preserved, should offer a rich source of paleoecological and ichnological data in the fossil record. The fossilized fragments of *B. zitteli* and *B. transplatina* valves yielded no *Caulostrepsis*, reinforcing the notion that those fossils came from populations that had not been infested by spionids.

Finally, it should be noted that multiple fossil examples documenting interactions between brachiopods and some ancient infesters were provided previously for several Paleozoic brachiopod taxa (e.g., Clarke 1908; Chatterton 1975; Rodrigues and Gutschick 1977; Vinn 2005; Daley 2008). The syn-vivo interactions between *Polydora* sp. and *B. rosea* documented here offer a useful modern analog that can augment ecological, behavioral, and taphonomic interpretations of infestation in ancient brachiopods.

## Conclusions

- This report provides direct present-day evidence for syn-vivo biotic interactions between spionid polychaetes (Spionidae, *Polydora* sp.) and their rhynchonelliform brachiopod hosts (see also Rodrigues 2007);
- Spionids responsible for *Caulostrepsis* traces were observed only in life-collected brachiopods providing thus a compelling example for *Caulostrepsis* traces that are predominantly (or perhaps even exclusively) pre-mortem rather than post-mortem in nature. Consequently, the use of such bioerosion traces as an indicator of a prolonged post-mortem exposure to taphonomic processes may not be warranted unless unambiguous evidence exists to validate such traces as post-mortem (e.g., location in shell regions that could not have been inhabited if the brachiopod host had been alive at the time of infestation);
- Even though *Caulostrepsis* traces occur syn-vivo, they do nevertheless weaken shells and make them more prone to fragmentation. Fortunately, the fragmentation often occurs via breakage along the surfaces defined by the traces. Thus, this biological facilitated fragmentation can be easily recognized in death assemblages and makes polychaete traces more noticeable;
- The complete absence of spionid borings in Holocene sympatric bivalve shells and the fact that *Bouchardia* fossils were not infested by such traces despite the fact that *Caulostrepsis* traces were common in fossil bivalve shells, both suggest that the Spionidae-*Bouchardia* association may be geologically young, and possibly very specific, biologic interaction. However, the absence of traces in fossil brachiopods may also reflect limited number of fossil sites and fossil brachiopod specimens that were accessible for this project.

## Acknowledgments

Funding for this project was provided by the São Paulo State Science Foundation (FAPESP), grants 00/12659-7 and 02/13552-7, and CNPq (the Federal Agency of Sciences, Brazil). The study was also supported by the National Science Foundation (OCE-0602375) and Petroleum Research Fund AC-PRF (40735-AC2) grants to MK. Personal thanks are extended to Adilson Fransozo (DZP) for providing assistance during the sampling program in the study area. Luiz Eduardo Anelli (Departamento de Geologia Sedimentar e Ambiental, USP, Sao Paulo, Brazil) kindly offered fossil bouchardiid specimens used in this study. We also thank Maria A. Bitner (Institute of Paleobiology PAS, Warsaw, Poland), Christan C. Emig (Centre d'Océanologie, Marseille, France), Pat Hutchings (Australian Museum, Sydney, Australia), and Max Wisshak (Institute of Palaeontology, Erlangen, Germany) for detailed reviews that greatly improved this manuscript.

## References

Abbott, R.T. and Dance, A. 1982. *Compendium of Seashells*. 280 pp. E.P. Dutton Inc., New York.

- Amaral, A.C.Z. and Nallin, S.A.H. 2004. *Catálogo das espécies dos Annelida Polychaeta da costa brasileira*. 106 pp. Campinas, São Paulo.
- Barreda, V. 1997. Palinoestratigrafía de la Formación San Julián en el área de Playa La Mina (provincia de Santa Cruz), Oligoceno de la Cuenca Austral. *Ameghiniana* 34: 283–294.
- Barrier, P. and d'Alessandro, A. 1985. Structures biogeniques et physiques dans les sables de Pavigliana Reggio Calabria (Italie). *Rivista Italiana di Paleontologia e Stratigrafia* 91: 379–408.
- Bertels, A. 1970. Sobre el "Piso Patagoniano" y la representación de la Epoca del Oligoceno en la Patagonia austral, República Argentina. *Revista de la Asociación Geológica Argentina* 25: 495–501.
- Bertels, A. 1977. Estratigrafía y micropaleontología de la Formación San Julián en su área tipo, Provincia de Santa Cruz, República Argentina. *Ameghiniana* 14: 233–293.
- Bitner, M.A. 1996. Encrusters and borers of brachiopods from the La Meseta Formation (Eocene) of Seymour Island. *Polish Polar Research* 17: 21–28.
- Blake, J.A. and Evans, J.W. 1973. *Polydora* and related genera as borers in mollusk shells and others calcareous substrates. *Veliger* 15: 235–249.
- Bromley, R.G. 1978. Bioerosion of Bermuda reefs. *Palaeogeography, Palaeoclimatology, Palaeoecology* 23: 169–197.
- Bromley, R.G. 1994. The palaeoecology of bioerosion. In: S.K. Donovan (ed.), *The Palaeobiology of Trace Fossils*, 134–154. John Wiley and Sons, Chichester.
- Bromley, R.G. and D'Alessandro, A. 1983. Bioerosion in the Pleistocene of southern Italy: ichnogenera *Caulostrepsis* and *Maeandropolydora*. *Rivista Italiana di Paleontologia e Stratigrafia* 89: 283–309.
- Brunton, C.H.C. 1996. The functional morphology of the Recent brachiopod *Bouchardia rosea*. *Acta Zoologica* 77: 233–240.
- Cáceres-Martínez, J., Tinoco, G.D., Bustamante, M.L.U., and Gómez-Humaran, I.M. 1999. Relationship between the burrowing polychaetes *Polydora* sp. and the black clam *Chione fluctifraga* Sowerby. *Journal of Shellfish Research* 18: 85–89.
- Camacho, H.H. 1974. Bioestratigrafía de las formaciones marinas del Eoceno y Oligoceno de la Patagonia. *Anales de la Academia Nacional de Ciencias Exactas, Físicas y Naturales de Buenos Aires* 26: 39–57.
- Carroll, M., Kowalewski, M., Simões, M.G., and Goodfriend, G.A. 2003. Quantitative estimates of time-averaging in brachiopod shell accumulations from a modern tropical shelf. *Paleobiology* 29: 382–403.
- Chatterton, B.D.E. 1975. A commensal relationship between a small filter feeding organism and Australian Devonian spiriferid brachiopods. *Paleobiology* 1: 371–378.
- Clarke, J.M. 1908. The beginnings of dependent life. *New York State Museum Bulletin* 121: 149–169.
- Daley, A.C. 2008. Statistical analysis of mixed-motive shell borings in Ordovician, Silurian, and Devonian brachiopods from northern and eastern Canada. *Canadian Journal of Earth Sciences* 45: 213–229.
- de Léo, F. 2003. *Estrutura e dinâmica da fauna benthica em regiões da plataforma e talude superior do Atlântico Sudoeste*. 163 pp. Unpublished M.Sc. thesis. Instituto Oceanográfico, Universidade de São Paulo.
- del Río, C.J. 2004. Tertiary marine Molluscan Assemblages of Eastern Patagonia (Argentina): a biostratigraphic analysis. *Journal of Paleontology* 78: 1097–1122.
- Figueiras, A. and Broggi, J. 1971. Estado actual de nuestros conocimientos sobre los moluscos fósiles del Uruguay. III (cont.). *Comunicaciones de la Sociedad Malacológica del Uruguay* 3 (21): 131–154.
- Hammond, L.S. 1984. Epibiota from the valves of Recent *Lingula* (Brachiopoda). *Journal of Paleontology* 58: 1527–1531.
- Herbst, R. and Zabert, L.L. 1987. Microfauna de la Fm. Paraná (Mioceno Superior) de la Cuenca Chaco-Paranense (Argentina). *Facena* 7: 165–206.
- Ihering, H. von 1907. Les mollusques fossiles du Tertiaire et du Crétacé supérieur de l'Argentine. *Annales del Museo Nacional de Buenos Aires Series 3A* 7: 469–481.
- Kowalewski, M. 2002. The fossil record of predation: An overview of analytical methods. In: M. Kowalewski and P.H. Kelley (eds.), *The Fossil Record of Predation: Paleontological Society Special Papers* 8: 3–42.
- Kowalewski, M., Simões, M.G., Carroll, M., and Rodland, D.L. 2002.

- Abundant brachiopods on a tropical, upwelling-influences shelf (south-east Brazilian Bight, South Atlantic). *Palaïos* 17: 277–286.
- Lorenzo, N. and Verde, M. 2004. Estructuras de bioerosión en moluscos marinos de la Formación Villa Soriano (Pleistoceno Tardío–Holoceno) de Uruguay. *Revista Brasileira de Paleontologia* 7: 319–328.
- MacKinnon, D.I. and Lee, D.E. 2006. Bouchardioidea. In: R.L. Kaesler (ed.) *Treatise of Invertebrate Paleontology, Part H, Brachiopoda, Revised, Volume 5*, 2223–2225. Geological Society of America, Boulder, and University of Kansas Press, Lawrence.
- Magliocca, A. and Kurtner, A.S. 1965. Sedimentos de fundo da Enseada do Flamengo, Ubatuba. *Contribuições do Instituto Oceanográfico* 198: 1–15.
- Mahiques, M.M. de, Tessler, M.G., and Furtado, V.V. 1998. Characterization of energy gradient in enclosed bays of Ubatuba region, Southeastern Brazil. *Estuarine, Coastal and Shelf Science* 47: 431–446.
- Mahiques, M.M. de, Tessler, M.G., Ciotti, A.M., Silveira, I.C.A., Sousa, S.H.M., Figueira, R.C.L., Tassinari, C.C.G., Furtado, V.V., and Passos, R.F. 2004. Hydrodynamically-driven patterns of recent sedimentation in the shelf and upper slope off southeast Brazil. *Continental Shelf Research* 24: 1685–1697.
- Manceñido, M.C. and Griffin, M. 1988. Distribution and environmental significance of the genus *Bouchardia* (Brachiopoda, Terebratulidina): Its bearing on the Cenozoic evolution of the South Atlantic. *Revista Brasileira de Geociências* 18: 201–211.
- Mantelatto, F.L.M. and Fransozo, A. 1999. Characterization of the physical and chemical parameters of Ubatuba Bay, northern coast of São Paulo State, Brazil. *Revista Brasileira de Biologia* 59: 23–31.
- Martin, L. and Suguio, K. 1976. O quaternário marinho do litoral do Estado de São Paulo. XXIX Congresso Brasileiro de Geologia. *Anais* 1: 281–293.
- Martin, L., Suguio, K., Flexor, J.M., Dominguez, J.M.L., and Bittencourt, C.S.P. 1996. Quaternary sea-level history and variation in dynamics along the central Brazilian coast: consequences on coastal plain construction. *Anais da Academia Brasileira de Ciências* 68: 303–354.
- Martínez, S. 1994. *Bioestratigrafía (Invertebrados) de la Formación Camacho (Mioceno, Uruguay)*. Unpublished Ph.D. thesis, 346 pp. Universidad de Buenos Aires, Argentina.
- Martínez, S. and del Río, C.J. 2002. Late Miocene Molluscs From the Southwestern Atlantic Ocean (Argentina and Uruguay): A Palaeobiogeographic Analysis. *Palaeogeography, Palaeoclimatology, Palaeoecology* 188: 167–187.
- Paiva, P.C. 1996. *Variação espacial e temporal da macrofauna bentônica da enseada de Picinguaba, Ubatuba, SP: relevância no planejamento amostral em estudos oceanográficos e de monitoramento ambiental de fundos marinhos inconsolidados*. Unpublished Ph.D. thesis. 102 pp. Instituto Oceanográfico, Universidade de São Paulo.
- Parras, A. and Casadío, S. 2006. The Oyster *Crassostrea? hatcheri* (Ortmann, 1897), a Physical Ecosystem Engineer from the Upper Oligocene–Lower Miocene of Patagonia, Southern Argentina. *Palaïos* 21: 168–186.
- Petti, M.A.V. 1997. *Macrofauna bentônica de fundos inconsolidados das enseadas de Picinguaba e Ubatumirim e plataforma interna adjacente, Ubatuba, São Paulo*. 163 pp. Unpublished Ph.D. thesis, Instituto Oceanográfico, Universidade de São Paulo.
- Pickerill, R.K. 1976. *Vermiforichnus* borings from the Ordovician of Central Wales. *Geological Magazine* 113: 159–164.
- Pickerill, R.K., Donovan, S.K., and Portell, R.W. 1998. Ichthyology of the Late Pleistocene Port Morant Formation of Southeastern Jamaica. *Caribbean Journal of Science* 34: 12–32.
- Pickerill, R.K., Donovan, S.K., and Portell, R.W. 2002. Bioerosional trace fossils from the Miocene of Carriacou, Lesser Antilles. *Caribbean Journal of Science* 38: 106–117.
- Richardson, J.R. 1981. Brachiopods and pedicles. *Paleobiology* 7: 87–95.
- Richardson, J.R. 1987. Brachiopods from carbonate sands of the Australian shelf. *Proceedings of the Royal Society of Victoria* 99: 37–50.
- Ríos, E. de C. 1994. *Seashells of Brazil. Segunda edição*. 368 pp. Editora Fundação Universidade do Rio Grande, Rio Grande.
- Rodland, D.L., Kowalewski, M., Simões, M.G., and Carroll, M. 2004. Colonization of a “Lost World”: encrustation patterns in modern subtropical brachiopod assemblages. *Palaïos* 19: 384–399.
- Rodland, D.L., Kowalewski, M., Carroll, M., and Simões, M.G. 2006. The temporal resolution of epibiont assemblages: are they ecological snapshots or overexposures? *Journal of Geology* 114: 313–324.
- Rodrigues, M., Mahiques, M.M. de, and Tessler, M.G. 2002. Sedimentação atual nas enseadas de Ubatumirim e Picinguaba, região norte de Ubatuba, Estado de São Paulo, Brasil. *Revista Brasileira de Oceanografia* 50: 27–45.
- Rodrigues, S.C. 2006. *Tafonomia de moluscos bivalves e braquiópodes das enseadas de Ubatuba e Picinguaba, norte do Estado de São Paulo: implicações do uso de assinaturas tafonômicas no reconhecimento de gradientes ambientais*. 118 pp. Unpublished Ph.D. thesis, Instituto de Geociências, Universidade de São Paulo.
- Rodrigues, S.C. 2007. Biotic interactions recorded in shells of recent Rhynchonelliform brachiopods from San Juan Island, USA. *Journal of Shellfish Research* 26: 241–252.
- Rodriguez, J. and Gutschick, R.C. 1977. Barnacle borings in live and dead hosts from the Louisiana Limestone (Fammenian) of Missouri. *Journal of Paleontology* 51: 718–724.
- Santos, M.F.L. 1998. *Estrutura e dinâmica da macrofauna benthica da enseada de Ubatuba, litoral norte de São Paulo, Brasil*. 155 pp. Unpublished Ph.D. thesis, Instituto Oceanográfico, Universidade de São Paulo.
- Scasso R.A., McArthur J.M., del Río, C.J., Martínez, S., and Thirlwall M.F. 2001. <sup>87</sup>Sr/<sup>86</sup>Sr Late Miocene age of fossil molluscs in the “Entrerriense” of the Valdés Península (Chubut, Argentina). *Journal of South American Earth Sciences* 14: 319–327.
- Simões, M.G., Kowalewski, M., Mello, L.H.C., Rodland, D.L., and Carroll, M. 2004a. Present-day terebratulid brachiopods from the southern Brazilian Shelf: Paleontological and biogeographic implications. *Palaëontology* 47: 515–532.
- Simões, M.G., Kowalewski, M., Carroll, M., Barbour-Wood, S., Krause, R.A.J., Rodrigues, S.C., and Wehmiller, J.F. 2004b. Taphonomy and time averaging as a tool in (paleo)oceanography: a case study on a shallow subtropical shelf from Brazil. In: XLII Congresso Brasileiro de Geologia. *Anais* S-27: 696.
- Simões, M.G., Rodrigues, S.C., and Kowalewski, M. 2007a. Comparative analysis of drilling frequencies in Recent brachiopod-mollusk associations from the Southern Brazilian Shelf. *Palaïos* 22: 141–152.
- Simões, M.G., Rodrigues, S.C., Leme, J.M., and Pires-Domingues, R.A., 2007b. Brachiopod shells on the beach: taphonomic Overprinting in a fair-weather shell accumulation and their paleoecological implications. *Journal of Taphonomy* 5 (4): 205–225.
- Suguio, K. 1999. *Geologia do Quaternário e mudanças ambientais: passado + presente = futuro?* 366 pp. Paulo’s Editora, São Paulo.
- Suguio, K. and Martin, L. 1976. Mecanismo de gênese das planícies sedimentares quaternárias do litoral do Estado de São Paulo do Estado de São Paulo. In: XXIX Congresso Brasileiro de Geologia. *Anais* 1: 295.
- Suguio, K., Absy, M.L., Flexor, J.M., Ledru, M.P., Martin, L., Sifeddine Soubiès, F., Turcq, B., and Ybert, J.P. 1993. The evolution of the continental and coastal environments during the last climatic cycle in Brazil (120 KY. B.P. to Present). *Boletim IG-USP Série Científica* 24: 27–41.
- Taylor, P.D. and Wilson, M.A. 2003. Palaeoecology and evolution of marine hard substrate communities. *Earth-Science Reviews* 62: 1–103.
- Tommasi, L.R. 1970. Sobre o braquiópode *Bouchardia rosea* (Mawe, 1823). *Boletim do Instituto Oceanográfico* 19: 33–42.
- Vinn, O. 2005. The distribution of polychaetes borings in brachiopod shells from the Caradoc Oil Shale of Estonia. *Notebooks on Geology* 3: 1–11.
- Wisshak, M. and Neumann, C. 2006. A symbiotic association of a boring polychaete and an echinoid from the Late Cretaceous of Germany. *Acta Palaeontologica Polonica* 51: 589–597.
- Zuschin, M., Stachowitsch, M., and Staton, R.J. Jr. 2003. Patterns and processes of shell fragmentation in modern and ancient marine environments. *Earth-Science Reviews* 63: 33–82.

## Appendix 1

Number of modern bivalve mollusk shells from collecting stations that also yielded *Bouchardia rosea* specimens.

Bivalve mollusk		Collecting sites				Shells	
Taxa	Mode of life	UBA 1 (30 m)	UBA 4 (25 m)	UBA 5 (20 m)	UBA 9 (10 m)	Total	Infested
<i>Anomia</i>	epifaunal	0	0	1	2	3	0
<i>Arca</i>	epifaunal	0	0	0	15	15	0
<i>Chlamys</i>	epifaunal	6	3	3	6	18	0
<i>Crassinella</i>	epifaunal	0	0	1	2	3	0
<i>Mytilus</i>	epifaunal	0	0	0	13	13	0
<i>Ostrea</i>	epifaunal	9	18	24	56	107	0
<i>Pecten</i>	epifaunal	7	7	11	7	32	0
<i>Pinna</i>	epifaunal	7	0	3	0	10	0
<i>Plicatula</i>	epifaunal	59	7	16	9	91	0
<i>Anadara</i>	semi-infaunal	1	21	10	19	51	0
<i>Atrina</i>	semi-infaunal	0	1	1	0	2	0
<i>Adrana</i>	infaunal	2	8	11	0	21	0
<i>Amiantes</i>	infaunal	4	3	5	2	14	0
<i>Anomalocardia</i>	infaunal	0	64	11	0	75	0
<i>Cardita</i>	infaunal	0	0	0	1	1	0
<i>Cardium</i>	infaunal	0	0	1	0	1	0
<i>Chione</i>	infaunal	8	11	8	18	45	0
<i>Corbula</i>	infaunal	2	4	10	26	42	0
<i>Diplodonta</i>	infaunal	0	2	2	0	4	0
<i>Divaricella</i>	infaunal	0	0	3	0	3	0
<i>Donax</i>	infaunal	1	0	5	0	6	0
<i>Dosinia</i>	infaunal	0	0	2	3	5	0
<i>Glycymeris</i>	infaunal	6	2	11	10	29	0
<i>Lucina</i>	infaunal	3	3	1	3	10	0
<i>Mactra</i>	infaunal	24	29	138	8	199	0
<i>Mya</i>	infaunal	0	0	0	3	3	0
<i>Nemocardium</i>	infaunal	0	2	0	0	2	0
<i>Nucula</i>	infaunal	0	4	5	0	9	0
<i>Periploma</i>	infaunal	2	1	0	0	3	0
<i>Pitar</i>	infaunal	0	1	0	10	11	0
<i>Raeta</i>	infaunal	0	2	2	0	4	0
<i>Semele</i>	infaunal	31	18	40	8	97	0
<i>Solen</i>	infaunal	1	0	2	17	20	0
<i>Spisula</i>	infaunal	0	4	7	4	15	0
<i>Tagelus</i>	infaunal	0	2	0	1	3	0
<i>Tellina</i>	infaunal	10	10	35	12	67	0
<i>Trachycardium</i>	infaunal	0	0	1	40	41	0
Undetermined	undetermined	335	222	213	240	1010	0